

# sparco®



CATALOGUE/2024/ENGLISH

RACING	SUITS UNDERWEAR
RACING	SHOES GLOVES
RACING	HELMETS
RACING	SEATS
RACING	HARNESSES STEERING WHEELS
RACING	MECHANICS TECHNICAL
KARTING	SUITS UNDERWEAR
KARTING	SHOES / GLOVES PROTECTIONS
PERFORMANCE	SEATS HARNESSES STEERING WHEELS
e-SPORTS	SIM RACING CHAIRS
TEAMWEAR & LIFESTYLE	CLOTHING ACCESSORIES
TEAMWEAR & LIFESTYLE	CAPSULE COLLECTIONS
OUTLET	



# OUR RACE TOWARD SUSTAINABILITY



PARENTAL POLICY  
3 STARS IN THE  
LEGALITY RATING  
CARBON  
NEUTRALITY TARGET

FULL EFFICIENCY  
PRODUCT LINE  
RENEWABLE ENERGY  
REFORESTING



Discover our projects for  
**ENVIRONMENTAL, SOCIAL  
and GOVERNANCE (ESG)**

TEAMWEAR & LIFESTYLE	CAPSULE COLLECTIONS	OUTLET
TEAMWEAR & LIFESTYLE	CLOTHING ACCESSORIES	
e-SPORTS	SIM RACING CHAIRS	
PERFORMANCE	SEATS HARNESSES STEERING WHEELS	
KARTING	SHOES / GLOVES PROTECTIONS	
KARTING	SUITS UNDERWEAR	
RACING	MECHANICS TECHNICAL	
RACING	HARNESSES STEERING WHEELS	
RACING	SEATS	
RACING	HELMETS	
RACING	SHOES GLOVES	
RACING	SUITS UNDERWEAR	



# SPARCO FORMULA 1 TEAMS



**IS**® WELCOME  
TO THE  
SPARCO  
WORLD.

# INDEX INDEX

## RACING RACING

pg. 8 - 243

Suits - Underwear - Shoes - Gloves - Helmets - Seats  
Harnesses - Steering Wheels - Mechanics / Technical

## KARTING KARTING

pg. 244 - 305

Suits - Underwear - Shoes  
Gloves - Protections

## PERFORMANCE PERFORMANCE

pg. 306 - 333

Seats - Harnesses - Steering Wheels

## E-SPORTS E-SPORTS

pg. 334 - 369

Sim Racing - Chairs

## TEAMWEAR & LIFESTYLE

pg. 370 - 437

Clothing - Funwear & Lifestyle - Bags - Accessories  
Youth & Baby - E-Mobility - Capsule Collections

## OUTLET OUTLET

pg. 438 - 456

SPARCO / CATALOGUE 2024

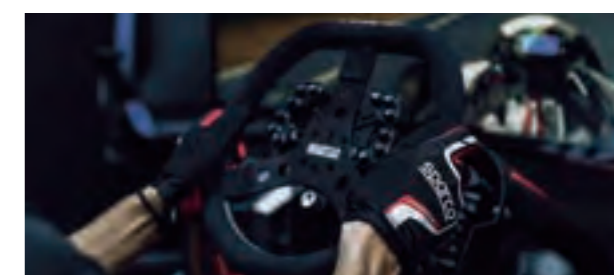

RACING	SUITS UNDERWEAR
RACING	SHOES GLOVES
RACING	HELMETS
RACING	SEATS
RACING	HARNESSES STEERING WHEELS
RACING	MECHANICS TECHNICAL
KARTING	SUITS UNDERWEAR
KARTING	SHOES / GLOVES PROTECTIONS
PERFORMANCE	SEATS HARNESSES STEERING WHEELS
e-SPORTS	SIM RACING CHAIRS
TEAMWEAR & LIFESTYLE	CLOTHING ACCESSORIES
TEAMWEAR & LIFESTYLE	CAPSULE COLLECTIONS
OUTLET	



# STANDARD SIZE CHARTS

# MADE TO MEASURE CHART

VIDEO TUTORIAL



YOUTH BODY SIZE CHART														
BABY	CHEST CIRCUMF.	WAIST CIRCUMF.	PELVIS CIRCUMF.	THIGH CIRCUMF.	SHOULDER WIDTH	SLEEVE LENGHT	FRONT CHEST LENGHT	EXTERNAL LEG LENGHT	INSEAM LEG LENGHT	BACK LENGHT	NECK CIRCUMF.	TOTAL CROTCH LENGHT	HEIGHT	WEIGHT
	CM	CM	CM	CM	CM	CM	CM	CM	CM	CM	CM	CM	CM	KG
AGE/SIZE	A	B	C	D	E	F	G	H	L	M	N	P		
6-7/120	60-63	55-60	69-71	37-39	28-30	44-47	41-44	67-71	52-54	29-31	32-34	104-106	116-125	20-23
8-9/130	64-67	61-63	72-75	40-42	31-33	48-51	45-48	75-79	57-60	32-34	34-36	107-110	128-135	24-28
10-11/140	68-71	64-67	76-79	43-44	34-36	52-55	49-52	83-87	63-66	35-37	37-39	111-113	136-145	29-36
12-13/150	72-75	68-71	80-83	45-47	37-39	56-59	53-56	91-95	69-72	38-41	40-42	114-117	146-155	37-44

MAN BODY SIZE CHART														
MAN	CHEST CIRCUMF.	WAIST CIRCUMF.	PELVIS CIRCUMF.	THIGH CIRCUMF.	SHOULDER WIDTH	SLEEVE LENGHT	FRONT CHEST LENGHT	EXTERNAL LEG LENGHT	INSEAM LEG LENGHT	BACK LENGHT	NECK CIRCUMF.	HEIGHT	WEIGHT	
	CM	CM	CM	CM	CM	CM	CM	CM	CM	CM	CM	CM	KG	
SIZES	A	B	C	D	E	F	G	H	L	M	N			
XS	44	86-89	74-77	86-89	45-48	37-40	54-57	62-64	97-100	72-74	41-43	37-38	164-167	54
	46	90-93	78-81	90-93	47-50	39-42	56-59	64-66	98-101	73-75	42-43	38-39	167-170	60
S	48	94-97	82-85	94-97	49-52	41-44	58-61	66-68	99-102	74-76	42-44	39-40	170-173	66
	50	98-101	86-87	98-101	51-54	42-46	60-63	68-70	100-103	75-77	43-44	40-41	173-176	72
M	52	102-105	88-93	102-105	54-57	45-48	62-65	70-72	101-104	76-78	44-45	41-42	176-179	78
	54	106-109	94-97	106-109	56-59	47-50	64-67	72-74	102-105	77-79	45-46	42-43	179-182	84
L	56	110-113	98-101	110-113	59-62	49-52	66-69	74-76	103-106	78-80	46-48	43-44	182-185	90
	58	114-117	102-105	114-117	61-64	51-54	68-71	76-78	103-107	79-81	48-49	45-46	185-188	96
XL	60	118-121	106-109	118-121	64-67	53-56	70-73	78-80	105-108	80-82	49-51	46-47	188-191	102
	62	122-125	110-113	122-125	67-70	56-58	72-75	80-82	107-110	81-83	51-52	47-48	191-194	108
XXL	64	126-129	114-117	126-129	69-72	57-60	74-77	82-84	108-111	82-84	52-54	48-50	194-197	114
	66	130-133	118-121	130-133	72-75	59-62	76-79	84-86	109-112	83-85	53-55	51-52	197-200	120

NB: If Your measurements differ from standard size, please verify with a tailor measuring tape and complete the Driver's chart measurements; it's recommended also complete the optional measures. Please note that these physical measurements charts are indicative only for commercial purposes, then are only useful for Sparco products. Note only for the youths product sizes. Take into account any uses of chest protectors and its related footprint.

LADY BODY SIZE CHART (CM)											
WOMAN	BREAST TAKEN ON THE MOST PROMINENT			WAIST CIRCUMF.	PELVIS CIRCUMF.	THIGH CIRCUMF.	ARM OUTSIDE	INSIDE LEG LENGHT	WEIGHT	HEIGHT	
INTERN. SIZES	UK	US	TG	A	B	C	D	F	L	KG	CM
XXS	6	2	38	78-81	60-63	84-87	51-52	55-58	71-73	45-49	160-162
				82-85	64-67	88-91	52-53	56-59	72-74	50-54	162-164
XS	8	4	42	86-89	68-71	92-95	53-54	57-60	73-75	55-59	164-166
				90-93	72-75	96-99	55-56	58-61	74-76	60-64	166-168
M	10	6	46	94-97	76-79	100-103	57-58	59-62	75-77	65-69	168-170
				98-101	80-83	104-107	59-60	60-63	76-78	70-74	170-172
L	12	8	50	102-105	84-87	108-111	61-62	61-64	77-79	75-79	172-174



Please note that this table is only intended as a guide and can differ from manufacturers measurements.

WIDTH CM	17	18,3	19,7	21	22,3	23	23,7	24,3	25	25,7	26,3	27	27,7	28,3	29	29,6	30,3	31	31,6
EUROPE	26	28	30	32	34	35	36	37	38	39	40	41	42	43	44	45	46	47	48
UK	11	12	13	1	2	2,5	3,5	4	5	5,5	6,5	7	8	9	9,5	10,5	11	12	13
USA	9,5	11	12,5	1	3	3,5	4,5	5	6	6,5	7,5	8	9	10	10,5	11,5	12	13	14

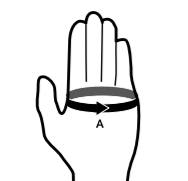

A											
SIZES	4	5	6	7	8	9	10	11	12	13	
INCH.	6,3-6,7	6,7-7	7-7½	7½-8	8-8½	8½-8,9	8,9-9,2	9,2-9,6	9,6-9,8	9,8-10	
CM	16-17	17-18	18-19	19-20,5	20,5-21,5	21,5-22,5	22,5-23,5	23,5-24,5	24,5-25	25-25,5	
USA	YXS	XXXXXS	XXXS	XXS	XS	S	M	L	XL	XXL	

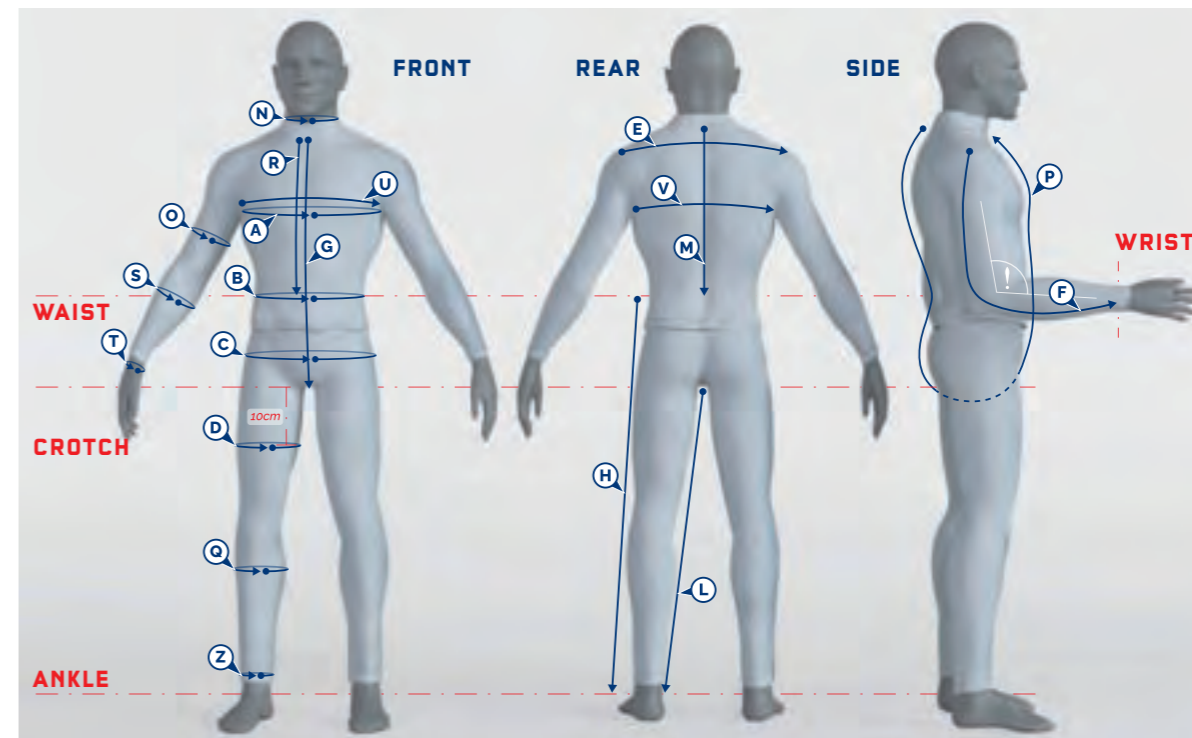

## GENERAL MEASURES

### A CHEST CIRCUMFERENCES

cm:   
Run tape measure under armpit, put in the largest part of the chest in horizontal position, arms relaxed at your sides.

### B WAIST CIRCUMFERENCE

cm:   
Run tape measure around waist horizontally, arms at your sides.

### C HIPS CIRCUMFERENCE

cm:   
Run tape measure around hips at the widest point, arms at your sides. (1820 cm under waist point)

### D THIGH CIRCUMFERENCE

cm:   
Measure the largest part of the thigh. Tape should be around 10 cm from below the crotch.

### E SHOULDER WIDTH

cm:   
Arms at your sides, run tape measure from bone to bone.

### F SLEEVE LENGTH

cm:   
Start the measurement from shoulder bone, running around elbow (arm flexed) ending at wrist.

### G FRONTAL CHEST LENGHT

cm:   
Take the measure starting from the notch of the neck down to below the crotch.

Height cm:

### H EXTERNAL LEG

cm:   
Run tape from waist to ankle bone.

### L INTERNAL LEG

cm:   
Run tape from crotch to internal ankle bone.

### M BASE OF NECK TO WAIST

cm:   
Run the tape measure from lower vertebra of the neck to the waist.

### N NECK CIRCUMFERENCE

cm:   
Run your tape measure around the neck at the thickest point.

### O BICEP CIRCUMFERENCE

cm:   
Run the tape measure around the widest point of the biceps.

### P TORSO LENGHT

cm:   
Starting from the notch of the neck in front, run tape through crotch to base of neck in back.

### Q CALF CIRCUMFERENCE

cm:   
Run tape measure around the widest point of the calf.

Weight kg:

### R NECK TO WAIST (FRONT)

cm:   
Run tape measure from notch of the neck in front to waist strap.

### S FOREARM CIRCUMFERENCE

cm:   
Run tape measure around waist horizontally, arms at your sides.

### T WRIST CIRCUMFERENCE

cm:   
Run the tape measure around the wrist bone.

### U CHEST WIDHT

cm:   
Arms at your sides, run tape measure from armpit to armpit.

### V BACK WIDTH

cm:   
Arms at your sides, run tape measure from armpit to armpit.

### Z ANKLE CIRCUMFERENCE

cm:   
Run the tape measure around the ankle bone.

We recommend sending photos of your full figure in the positions shown above to better understand the distribution of your measurements.





# STANDARD COLOUR CHARTS

## PRIME

 MT0100008B0	 MT0100008GRL	 MT0100008GR423C	 MT0100008GR431C	 MT01000087545C	 MT0100008GRS	 MT0100008GR152
 MT0100008AMR	 MT0100008VDLT	 MT0100008MG	 MT0100008285C	 MT0100008CE	 MT0100008AZ	 MT0100008BM
 MT0100008RS201C	 MT0100008RS	 MT0100008AR804C	 MT0100008AR166C	 MT0100008AR149	 MT0100008GL	 MT0100008GF
 MT0100008NR						

## SUPERLEGGERA

 MT0100008B0	 MT0100008GRL	 MT0100008GR423C	 MT0100008GR431C	 MT01000087545C	 MT0100008GRS	 MT0100008GR152
 MT0100008AMR	 MT0100008VDLT	 MT0100008MG	 MT0100008285C	 MT0100008CE	 MT0100008AZ	 MT0100008BM
 MT0100008RS201C	 MT0100008RS	 MT0100008AR804C	 MT0100008AR166C	 MT0100008AR149	 MT0100008GL	 MT0100008GF
 MT0100008NR						

## COMPETITION • LADY • VINTAGE

 MT0100011BL1	 MT0100011FG121	 MT0100011GR1	 MT0100011GRS1	 MT0100011CG11C	 MT0100011NL1	 MT0100011BML1
 MT0100011PP	 MT0100011BRFXC1	 MT0100011AL1	 MT0100011CE	 MT0100011VML	 MT0100011VD1	 MT0100011VULTIM
 MT0100008RS201C	 MT0100008RS	 MT0100008AR804C	 MT0100008AR166C	 MT0100008AR149	 MT0100008GL	 MT0100008GF
 MT0100011GL	 MT0100011GL1	 MT0100011GLJ	 MT0100011GOLD1	 MT0100011AR804C	 MT0100011RFE1	 MT0100011RFL1

## FUTURA

 MT010047LBO	 MT010047LGR423C	 MT010047LNR	 MT010047BM116B	 MT010047LBM	 MT010047LBEL	 MT010047LAZ
 MT010047LVF	 MT010047LGF	 MT010047LRCI	 MT010047LPINK			

## SPRINT

 MT010047LBO	 MT010047LGR423C	 MT010047LNR	 MT010047BM116B	 MT010047LBM	 MT010047LBEL	 MT010047LAZ
 MT010047LVF	 MT010047LGF	 MT010047LRCI	 MT010047LPINK			

## ADVENTURE

 MT0100008WB0	 MT0100008WGRS	 MT0100008WNR	 MT0100008WBM	 MT0100008WRS
---	--	---	---	---

## ICE VEST

 MT0100008B0	 MT0100008GRL	 MT0100008GR423C	 MT0100008GR431C	 MT01000087545C	 MT0100008GRS	 MT0100008GR152
 MT0100008AMR	 MT0100008VDLT	 MT0100008MG	 MT0100008285C	 MT0100008CE	 MT0100008AZ	 MT0100008BM
 MT0100008RS201C	 MT0100008RS	 MT0100008AR804C	 MT0100008AR166C	 MT0100008AR149	 MT0100008GL	 MT0100008GF
 MT0100008NR						

## JACKET • PANT FIA

 MT0100008B0	 MT0100008GRL	 MT0100008GR423C	 MT0100008GR431C	 MT01000087545C	 MT0100008GRS	 MT0100008GR152
 MT0100008AMR	 MT0100008VDLT	 MT0100008MG	 MT0100008285C	 MT0100008CE	 MT0100008AZ	 MT0100008BM
 MT0100008RS201C	 MT0100008RS	 MT0100008AR804C	 MT0100008AR166C	 MT0100008AR149	 MT0100008GL	 MT0100008GF
 MT0100008NR						



# D R A P I N G S U I T S K A R T I N G



TEAMWEAR & LIFESTYLE	CAPSULE COLLECTIONS	OUTLET
TEAMWEAR & LIFESTYLE	CLOTHING ACCESSORIES	
e-SPORTS	SIM RACING CHAIRS	
PERFORMANCE	SEATS HARNESSES STEERING WHEELS	
KARTING	SHOES / GLOVES PROTECTIONS	
KARTING	SUITS UNDERWEAR	
RACING	MECHANICS TECHNICAL	
RACING	HARNESSES STEERING WHEELS	
RACING	SEATS	
RACING	HELMETS	
RACING	SHOES GLOVES	
RACING	SUITS UNDERWEAR	



## SUPERLEGGERA

### HOMOLOGATION:

FIA 8856-2018  
SFI 3.2A/5

**SIZES:** 48-66

### CUSTOMIZATION:

- CUSTOM EASY
- ON DEMAND



001142..RNBI 001142..BMBI 001142..NBAZ 001142..NRGR 001142..GSGF

## PRIME

### HOMOLOGATION:

FIA 8856-2018  
SFI 3.2A/5

**SIZES:** 48-66

### CUSTOMIZATION:

ON DEMAND



001146..BI 001146..NR 001146..NRGF

## INFINITY 5.0

### HOMOLOGATION:

FIA 8856-2018  
SFI 3.4/5 ON DEMAND

**SIZES:** ON DEMAND

### CUSTOMIZATION:

ON DEMAND



0011030..GSGF

## COMPETITION

### HOMOLOGATION:

FIA 8856-2018  
SFI 3.2A/5

**MAN SIZES:** 48-66

**LADY SIZES:** 36-50

### CUSTOMIZATION:

ON DEMAND



001144..BNAF 001144..BRNR 001144..BMBB 001144..NRRB 001144..NBGR 001144..NRGF  
001144L..BRNR 001144L..NRRB

## VINTAGE CLASSIC

### HOMOLOGATION:

FIA 8856-2018  
SFI 3.2A/5

**SIZES:** 48-66

### CUSTOMIZATION:

ON DEMAND



001144V..BI

## FUTURA

### HOMOLOGATION:

FIA 8856-2018  
SFI 3.2A/5 ON DEMAND

**SIZES:** 48-66

### CUSTOMIZATION:

- CUSTOM EASY
- ON DEMAND



001155..RS 001155..NRGR 001155..NRVF 001155..NRGF

## SPRINT

### HOMOLOGATION:

FIA 8856-2018  
SFI 3.2A/5

**SIZES:** 48-66

### CUSTOMIZATION:

- CUSTOM EASY
- 3D CONFIGURATOR
- ON DEMAND



001093..RSNR 001093..BELN 001093..BMBI 001093..NRRS 001093..NR 001093..NRVF 001093..NRGF

## ONE

### HOMOLOGATION:

SFI 3.2A/1

**SIZES:** S-XXL

### CUSTOMIZATION:

NOT CUSTOMIZABLE



001059NRRS.. 001059NRAZ.. 001059NRBI..

## ADVENTURE JACKET

### HOMOLOGATION:

FIA 8856-2018

**SIZES:** 48-66

### CUSTOMIZATION:

ON DEMAND



001049BM..

## ICE VEST

**SIZES:** XS-3XL

### CUSTOMIZATION:

ON DEMAND



001014SI..



**HOMOLOGATION:** FIA 8856-2018 - SFI 3.2A/5  
**SIZES:** 48-66  
**CUSTOMIZATION:** CUSTOM EASY / ON DEMAND

MANUFACTURER: SPARCO  
MODEL: R564  
HOM. NO: DC.142.21-0  
FIA STANDARD: 8856-2018

**M. Verstappen**  
Oracle Red Bull Racing Team  
3 times F1 World Champion  
2021/2022/2023



## HIGHLIGHTS



Extraction handle.



Large rear stretch panel.



**LADY FIT  
ON DEMAND**

## LIGHTNESS UNMATCHED



**001142..RNBI**



**001142..BMBI**

**001142..NBAZ**

**001142..NRGR**

**001142..GSGF**

RACING	SUITS
RACING	SHOES GLOVES
RACING	HELMETS
RACING	SEATS
RACING	HARNESSES STEERING WHEELS
RACING	MECHANICS TECHNICAL
KARTING	SUITS UNDERWEAR
KARTING	SHOES / GLOVES PROTECTIONS
PERFORMANCE	SEATS HARNESSES STEERING WHEELS
e-SPORTS	SIM RACING CHAIRS
TEAMWEAR & LIFESTYLE	CLOTHING ACCESSORIES
TEAMWEAR & LIFESTYLE	CAPSULE COLLECTIONS
OUTLET	



**HOMOLOGATION:** FIA 8856-2018 - SFI 3.2A/5  
**SIZES:** 48-66  
**CUSTOMIZATION:** ON DEMAND

MANUFACTURER: SPARCO  
 MODEL: R568  
 HOM. NO: DC.169.21-O  
 FIA STANDARD: 8856-2018

**G. Bortoletto**  
 Team Trident  
 FIA F3 World Champion



## HIGHLIGHTS



Full floating 360°  
 Arm Gussets.



Large rear stretch panel.



**LADY FIT**  
**ON DEMAND**

## MAXIMUM LEVEL OF PERFORMANCE



**001146..NRGF**



**001146..BI**

**001146..NR**



RACING	SUITS
RACING	SHOES GLOVES
RACING	HELMETS
RACING	SEATS
RACING	HARNESSES STEERING WHEELS
RACING	MECHANICS TECHNICAL
KARTING	SUITS UNDERWEAR
KARTING	SHOES / GLOVES PROTECTIONS
PERFORMANCE	SEATS HARNESSES STEERING WHEELS
e-SPORTS	SIM RACING CHAIRS
TEAMWEAR & LIFESTYLE	CLOTHING ACCESSORIES
TEAMWEAR & LIFESTYLE	CAPSULE COLLECTIONS
OUTLET	



**HOMOLOGATION:** FIA 8856-2018 - (SFI 3.4/5 ON DEMAND)  
**SIZES:** 48-66  
**CUSTOMIZATION:** ON DEMAND

MANUFACTURER: SPARCO  
 MODEL: R576  
 HOM. NO: DC.275.22-O  
 FIA STANDARD: 8856-2018



T. Reddick  
 23XI Racing  
 NASCAR Cup Series

## HIGHLIGHTS



Extraction handle.



Elasticated rear and side inserts.



Sublimation printing graphics.

NO LIMITS TO YOUR CREATIVITY



Unlimited creativity thanks to the latest technology in sublimation printing.

**New light compound (2 layers).**



0011030..GSGF

RACING	SUITS
RACING	SHOES GLOVES
RACING	HELMETS
RACING	SEATS
RACING	HARNESSES STEERING WHEELS
RACING	MECHANICS TECHNICAL
KARTING	SUITS UNDERWEAR
KARTING	SHOES / GLOVES PROTECTIONS
PERFORMANCE	SEATS HARNESSES STEERING WHEELS
e-SPORTS	SIM RACING CHAIRS
TEAMWEAR & LIFESTYLE	CLOTHING ACCESSORIES
TEAMWEAR & LIFESTYLE	CAPSULE COLLECTIONS
OUTLET	



**HOMOLOGATION:** FIA 8856-2018 - SFI 3.2A/5  
**SIZES:** 48-66 / COMPETITION LADY 36-50  
**CUSTOMIZATION:** ON DEMAND

MANUFACTURER: SPARCO  
 MODEL: R567  
 HOM. NO: DC.163.21-O  
 FIA STANDARD: 8856-2018



A. Iwasa  
 DAMS - Red Bull Junior Team  
 Formula 2

## HIGHLIGHTS



Extraction handle.



Large rear stretch panel.



LADY FIT

## COMPETITION READY



001144..BNAF



001144..BMBB    001144..NBGR    001144..NRGF



001144..BRNR    001144..NRRB

COMPETITION LADY  
 001144L..BRNR    001144L..NRRB

RACING	SUITS
RACING	SHOES GLOVES
RACING	HELMETS
RACING	SEATS
RACING	HARNESSES STEERING WHEELS
RACING	MECHANICS TECHNICAL
KARTING	SUITS UNDERWEAR
KARTING	SHOES / GLOVES PROTECTIONS
PERFORMANCE	SEATS HARNESSES STEERING WHEELS
e-SPORTS	SIM RACING CHAIRS
TEAMWEAR & LIFESTYLE	CLOTHING ACCESSORIES
TEAMWEAR & LIFESTYLE	CAPSULE COLLECTIONS
OUTLET	





**HOMOLOGATION:** FIA 8856-2018 - (SFI 3.2A/5 ON DEMAND)  
**SIZE:** 48-66  
**CUSTOMIZATION:** ON DEMAND

MANUFACTURER: SPARCO  
 MODEL: R579  
 HOM. NO: DC.290.22-O  
 FIA STANDARD: 8856-2018

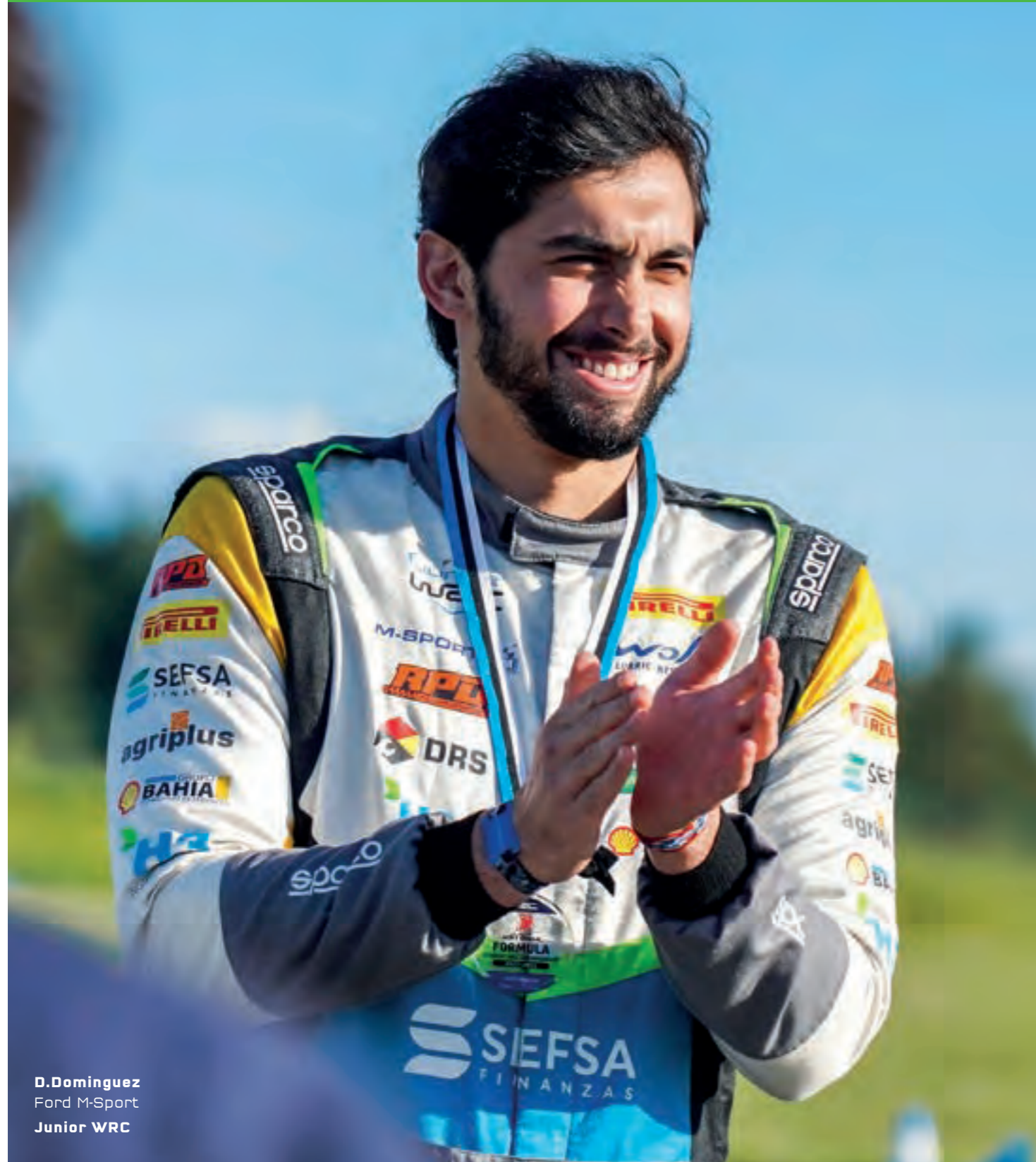

**D. Dominguez**  
 Ford M-Sport  
 Junior WRC

## HIGHLIGHTS



Extraction handle made in regenerated FULL EFFICIENCY material.

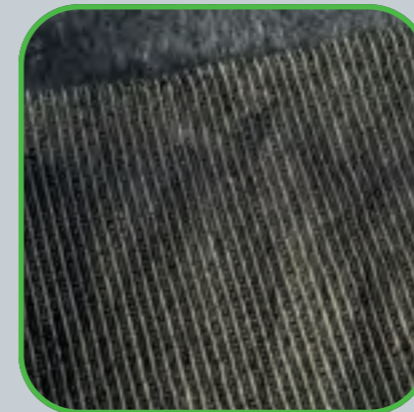

Mid Layer and Lining made with FULL EFFICIENCY regenerated fabric.



Reinforcements in sparco® FULL EFFICIENCY regenerated fabric. Inner thigh stretch insert.

## GREEN LIGHT



001155..NRVF

FULL EFFICIENCY zero-waste foldable suit bag included.



001155..RS

001155..NRGR

001155..NRGF



- LCA (Life Cycle Assessment) certified.
- 21% REDUCTION of the impact on climate change.\*
- 70% of regenerated fibers.
- ZERO WASTE.\*\*

\*Value to be compared to a traditional production. The reduction equals the amount of CO2 released into the environment traveling approx. 58 km by car.  
 \*\*Target achieved through the regeneration of the fibers used in mass production.

RACING	SUITS
RACING	SHOES GLOVES
RACING	HELMETS
RACING	SEATS
RACING	HARNESES STEERING WHEELS
RACING	MECHANICS TECHNICAL
KARTING	SUITS UNDERWEAR
KARTING	SHOES / GLOVES PROTECTIONS
PERFORMANCE	SEATS HARNESES STEERING WHEELS
e-SPORTS	SIM RACING CHAIRS
TEAMWEAR & LIFESTYLE	CLOTHING ACCESSORIES
TEAMWEAR & LIFESTYLE	CAPSULE COLLECTIONS
OUTLET	



**HOMOLOGATION:** FIA 8856-2018 - SFI 3.2A/5  
**SIZES:** 48-66 (44-66 NR VERSION ONLY) / KIDS SIZES 120-150 ON DEMAND  
**CUSTOMIZATION:** CUSTOM EASY / 3D CONFIGURATOR / ON DEMAND

MANUFACTURER: SPARCO  
 MODEL: R566  
 HOM. NO: DC.159.21-O  
 FIA STANDARD: 8856-2018

**V. Ledda**

Winner of the 2023 Italian Rally Cross Championship  
 2023 Latvian Rally Championship (LRC4)



## HIGHLIGHTS



Extraction handle.



Large rear stretch panel.



LADY AND KID FIT  
ON DEMAND

## VALUE & PERFORMANCE



001093..NRRS



001093..RSNR



001093..BELN



001093..BMBI



001093..NRVF



001093..NRGF



001093..NR



# VINTAGE CLASSIC

HOMOLOGATION: FIA 8856-2018 - SFI 3.2A/5  
SIZES: 48-66  
CUSTOMIZATION: ON DEMAND



MANUFACTURER: SPARCO  
MODEL: R567  
HOM. NO: DC.163.21-O  
FIA STANDARD: 8856-2018

# ONE

HOMOLOGATION: SFI 3.2A/1  
SIZES: S-XXL  
CUSTOMIZATION: NOT CUSTOMIZABLE

## HIGHLIGHTS



Original Sparco epaulets.



Form fitting rear elastic.



Period correct front belt.

## RETRO STYLE WITH MODERN TECHNOLOGY



001144V..BI

## HIGHLIGHTS



Extraction handle.



Form fitting rear elastic.



Adjustable ankle closure.

## SINGLE LAYER PROTECTION



001059NRRS..



001059NRAZ..

001059NRBI..



# ADVENTURE JACKET



**HOMOLOGATION:** FIA 8856-2018  
**SIZES:** XS-3XL  
**CUSTOMIZATION:** ON DEMAND

MANUFACTURER: SPARCO  
MODEL: R575  
HOM. NO: DC.274.22-R  
FIA STANDARD: 8856-2018



**R. Busi**  
OnlyFans Racing Team  
World Rally Raid Championship

## HIGHLIGHTS



Outer material waterproof with flame retardant PTFE membrane.

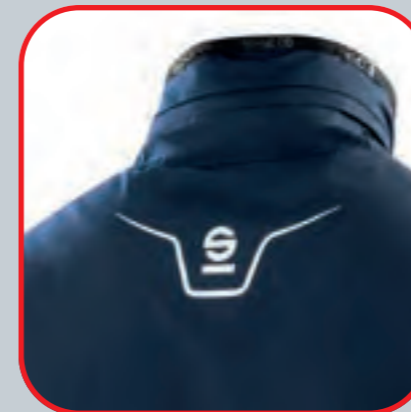

Foldaway hood.



Transfer print decorations.



**TO OVERCOME  
EVERY LIMIT**



**001049BM..**

RACING	SUITS
RACING	SHOES GLOVES
RACING	HELMETS
RACING	SEATS
RACING	HARNESSES STEERING WHEELS
RACING	MECHANICS TECHNICAL
KARTING	SUITS UNDERWEAR
KARTING	SHOES / GLOVES PROTECTIONS
PERFORMANCE	SEATS HARNESSES STEERING WHEELS
e-SPORTS	SIM RACING CHAIRS
TEAMWEAR & LIFESTYLE	CLOTHING ACCESSORIES
TEAMWEAR & LIFESTYLE	CAPSULE COLLECTIONS
OUTLET	







# DACING UNDERWEAR RACING



TEAMWEAR & LIFESTYLE	TEAMWEAR & LIFESTYLE	e-SPORTS	PERFORMANCE	KARTING	KARTING	RACING	RACING	RACING	RACING	RACING	RACING	RACING
CAPSULE COLLECTIONS	CLOTHING ACCESSORIES	SIM RACING CHAIRS	SEATS HARNESSES STEERING WHEELS	SHOES / GLOVES PROTECTIONS	SUITS UNDERWEAR	MECHANICS TECHNICAL	HARNESSES STEERING WHEELS	SEATS	HELMETS	SHOES GLOVES	UNDERWEAR	OUTLET



## RW-11 EVO

HOMOLOGATION:  
FIA 8856-2018  
SFI 3.3



001789MBO..



001789MNR..



001789PBO..



001789PNR..

## RW-10 SHIELD PRO

HOMOLOGATION:  
FIA 8856-2018  
SFI 3.3



001786MBO..



001786MNR..



001786MGR..



001786MBM..



001769PBO..



001786PNR..



001786PGR..



001786PBM..

## RW-7 DELTA

HOMOLOGATION:  
FIA 8856-2018  
SFI 3.3



001780MBO..



001780MNR..



001781PBO..



001781PNR..

## RW-4 GUARD

HOMOLOGATION:  
FIA 8856-2018  
SFI 3.3



001782MBI..



001782PBI..



001797BI..



001711BBI..

## PISTA BALACLAVA

HOMOLOGATION:  
FIA 8856-2018  
SFI 3.3



001409BO



001409NR

## RW-7 DELTA BALACLAVA

HOMOLOGATION:  
FIA 8856-2018  
SFI 3.3



001410BO



001410NR

## RW-10 SHIELD PRO BALACLAVA

HOMOLOGATION:  
FIA 8856-2018  
SFI 3.3



001407BO



001407NR



001407BM

## RW-4 GUARD BALACLAVA

HOMOLOGATION:  
FIA 8856-2018  
SFI 3.3

NOT FIA



001487BI



001488BI

## RACING UNDERGARMENTS

HOMOLOGATION:  
FIA 8856-2018



001788



001787



001785



001790

## RW-10 EVO SOCKS

HOMOLOGATION:  
FIA 8856-2018



001523BI..



001523NR..

## RW-7 DELTA SOCKS

HOMOLOGATION:  
FIA 8856-2018



001522BI..



001522NR..

## RW-4 GUARD SOCKS

HOMOLOGATION:  
FIA 8856-2018



001516BI..





**THE LIGHTEST  
ON THE MARKET**

**HOMOLOGATION:** FIA 8856-2018 - SFI 3.3

**S. Quintero**  
Red Bull Dakar Driver Off-Road Team  
World Rally-Raid Championship



001789MBO..

001789MNR..

**FIA APPROVED**

MANUFACTURER: SPARCO  
MODEL: R577 TOP  
HOM. NO: DC.281.22-T  
FIA STANDARD: 8856-2018

**SIZES:**  
XS - S - M - L - XL - XXL - 3XL

- Fully seamless structure.
- Ultra-light construction.
- X-COOL treatment, reactive cooling and anti-bacterial.
- Transfer print logos.
- Material: 48% Meta-Aramid, 48% Modal Viscose, 4% Elastane.



001789PBO..

001789PNR..

**FIA APPROVED**

MANUFACTURER: SPARCO  
MODEL: R577 BOTTOM  
HOM. NO: DC.282.22-L  
FIA STANDARD: 8856-2018

**SIZES:**  
XS - S - M - L - XL - XXL - 3XL

- Fully seamless structure.
- Ultra-light construction.
- X-COOL treatment, reactive cooling and anti-bacterial.
- Transfer print logos.
- Material: 48% Meta-Aramid, 48% Modal Viscose, 4% Elastane.

RACING	UNDERWEAR
RACING	SHOES GLOVES
RACING	HELMETS
RACING	SEATS
RACING	HARNESSES STEERING WHEELS
RACING	MECHANICS TECHNICAL
KARTING	SUITS UNDERWEAR
KARTING	SHOES / GLOVES PROTECTIONS
PERFORMANCE	SEATS HARNESSES STEERING WHEELS
e-SPORTS	SIM RACING CHAIRS
TEAMWEAR & LIFESTYLE	CLOTHING ACCESSORIES
TEAMWEAR & LIFESTYLE	CAPSULE COLLECTIONS
OUTLET	



# RW-10 SHIELD PRO

HOMOLOGATION: FIA 8856-2018 - SFI 3.3

**S. Perez**  
Oracle Red Bull Racing Team  
F1 2023 Runner-Up



**SIZES:**  
XS - S/M - L/XL - XXL

- Seamless construction.
- X-COOL treatment, reactive cooling and anti bacterial.
- Material: 69% Modal Viscose, 28% Meta-Aramid, 2% Elastane, 1% Antistatic fiber.



001786MBO..



001786MNR..



001786MGR..



001786MBM..

**SIZES:**  
XS - S/M - L/XL - XXL

- Seamless construction.
- X-COOL treatment, reactive cooling and anti-bacterial.
- Material: 69% Modal Viscose, 28% Meta-Aramid, 2% Elastane, 1% Antistatic fiber.



001786PBO..



001786PNR..



001786PGR..



001786PBM..











## NEW BALACLAVA PISTA

ONE SIZE



001409BO

001409NR



- FIA 8856-2018 - SFI 3.3 approved fireproof balaclava.
- Composition: 62% VISCOSE 31% (META)ARAMID 5% XLANCE 2% (PARA)ARAMIDE.
- Balaclava with features derived from F1: microphone holder, cable glands and ultra-flat seams.

## BALACLAVA RW-10 SHIELD PRO

ONE SIZE



001407BO

001407NR

001407BM



- Opening for drink system.
- Seamless front chin.
- Extra-flat offset crown seams.
- Double layer on front.
- Material: 69% Modal Viscose, 28% Meta-Aramid, 1% Antistatic fiber, 2% Elastane.

## BALACLAVA RW-7 DELTA

ONE SIZE



001410BO

001410NR



- FIA 8856-2018 - SFI 3.3 approved fireproof balaclava.
- Composition: 57% VISCOSE, 38% (META)ARAMIDE, 3% PARA(ARAMIDE), 2% ELASTANE.
- Differentiated armor between front and back, knitted fibers in "BODY-SIZE" structure, improved eye hole stitching for greater comfort.

## BALACLAVA RW-4 GUARD

ONE SIZE



001487BI



- Soft-touch interlock construction.
- Simplified and optimised structure.
- Composition: 60% modacrylic, 40% cellulose.

## BALACLAVA RW-4 GUARD NOT FIA

ONE SIZE



001488BI

- Single-layer balaclava.
- Soft-touch interlock construction.

## RACE UNDERGARMENTS (FIA COMPLIANT)

- FIA approved 8856-2018 undergarment.
- No stitching on the front.
- Material: 55% modacrylic, 45% cotton.

### RACE SPORT BRA



001788BI..



SIZES: XS - S - M - L

### MEN RACE BOXER



001785BI..

SIZES: XS - S/M - L/XL - XXL

### MEN RACE SLIP



001790BI..

SIZES: XS - S/M - L/XL - XXL

### LADY RACE SHORTS



001787BI..

SIZES: XS - S - M - L













## PRIME EXTREME NEW

**HOMOLOGATION:** FIA 8856-2018 - SFI 3.3/5  
**MATERIAL:** ULTRALIGHT SUBLIMATED FABRIC  
**SOLE:** OIL AND HYDROCARBON RESISTANT RUBBER + CARBON  
**SIZES:** 37-47 **CUSTOMIZATION:** ON DEMAND



0012A9..BMRS

0012A9SP01

## SUPERLEGGERA

**HOMOLOGATION:** FIA 8856-2018 - SFI 3.3/5  
**MATERIAL:** SUBLIMATED FABRIC AND JACQUARD FABRIC  
**SOLE:** OIL AND HYDROCARBON RESISTANT RUBBER + CARBON  
**SIZES:** 37-48 **CUSTOMIZATION:** ON DEMAND



0012A3..BINR

0012A3..NRBI

0012A3..NRRS

0012A3..NRGF

0012A3SP01

## PRIME EVO LITE NEW

**HOMOLOGATION:** FIA 8856-2018 - SFI 3.3/5  
**MATERIAL:** ULTRALIGHT SUBLIMATED FABRIC WITH JACQUARD INSERTS  
**SOLE:** OIL AND HYDROCARBON RESISTANT RUBBER + CARBON  
**SIZES:** 37-48 **CUSTOMIZATION:** ON DEMAND



0012B1SP

0012B1SP01

## PRIME EVO

**HOMOLOGATION:** FIA 8856-2018  
**MATERIAL:** KANGAROO LEATHER WITH JACQUARD INSERTS  
**SOLE:** OIL AND HYDROCARBON RESISTANT RUBBER + CARBON  
**SIZES:** 37-48 **CUSTOMIZATION:** ON DEMAND



001297..BI

001297..NR

001297..RS

001297..GRGF

001297..BMRS

## X-LIGHT+

**HOMOLOGATION:** FIA 8856-2018 - SFI 3.3/5 ON DEMAND  
**MATERIAL:** KANGAROO LEATHER AND JACQUARD FABRIC  
**SOLE:** OIL AND HYDROCARBON RESISTANT RUBBER + CARBON  
**SIZES:** 39-46 **CUSTOMIZATION:** ON DEMAND



001278..BINR

001278..NR

001278..NRRS

001278..NRAF

001278..NRGF

## X-LIGHT

**HOMOLOGATION:** FIA 8856-2018 - SFI 3.3/5 (ON DEMAND)  
**MATERIAL:** TUMBLED LEATHER AND PU LEATHER  
**SOLE:** TPU FR + EVA  
**SIZES:** 37-48 **CUSTOMIZATION:** ON DEMAND



001283..BIRS

001283..NRGR

001283..GRAF

001283..NRGF

## FORMULA

**HOMOLOGATION:** FIA 8856-2018 - SFI 3.3/5  
**MATERIAL:** TUMBLED LEATHER  
**SOLE:** OIL AND HYDROCARBON RESISTANT RUBBER  
**SIZES:** 37-48 (32-34-36-49-50 ON DEMAND) **CUSTOMIZATION:** ON DEMAND



001296..BINR

001296..NRBI

001296..NRRS

001296..BXBI

## SKID

**HOMOLOGATION:** FIA 8856-2018 - SFI 3.3/5  
**MATERIAL:** TUMBLED LEATHER AND PU LEATHER  
**SOLE:** TPU FR + EVA  
**SIZES:** 37-48 **CUSTOMIZATION:** ON DEMAND



001275..BIBI

0012A3..NRNR

001275..RSNR

001275..BNBI



## CHRONO NEW

**HOMOLOGATION:** FIA 8856-2018 - SFI 3.3/5  
**MATERIAL:** SMOOTH GENUINE LEATHER WITH PERFORATED SUEDE  
**SOLE:** OIL AND HYDROCARBON RESISTANT RUBBER + PHYLON  
**SIZES:** 38-48 **CUSTOMIZATION:** ON DEMAND



0012B2..NRNR

0012B2..NRRS

## TOP

**HOMOLOGATION:** FIA 8856-2018  
**MATERIAL:** CALF LEATHER  
**SOLE:** OIL AND HYDROCARBON RESISTANT RUBBER  
**SIZES:** 37-48 **CUSTOMIZATION:** ON DEMAND



001287..NR

001287..RS

001287..BRFX

## SLALOM+

**HOMOLOGATION:** FIA 8856-2018 - SFI 3.3/5  
**MATERIAL:** FULL SUEDE  
**SOLE:** OIL AND HYDROCARBON RESISTANT RUBBER  
**SIZES:** 35-48 (28-30-32-34 ON DEMAND) **CUSTOMIZATION:** ON DEMAND



001274..NR

001274..RS

001274..BRFX

## SLALOM

**HOMOLOGATION:** FIA 8856-2018 - SFI 3.3/5  
**MATERIAL:** FULL SUEDE  
**SOLE:** OIL AND HYDROCARBON RESISTANT RUBBER  
**SIZES:** 36-48



001295..NR

001295..NRRS

001295..BRFX

001295..NRGF

001295..NRVF

## FUTURA

**HOMOLOGATION:** FIA 8856-2018 - SFI 3.3/5  
**MATERIAL:** FULL EFFICIENCY CLOTHES  
**SOLE:** OIL AND HYDROCARBON RESISTANT RUBBER  
**SIZES:** 36-48 **CUSTOMIZATION:** ON DEMAND



0012A4..GRVF



0012A4..GRBI





**HOMOLOGATION:** FIA 8856-2018 - SFI 3.3/5  
**WEIGHT:** 198 GR. (SIZE 42) **SIZES:** 37-47  
**CUSTOMIZATION:** ON DEMAND

MANUFACTURER: SPARCO  
MODEL: PRIME R FABRIC  
HOM. NO: DC.338.23-Z  
FIA STANDARD: 8856-2018



## HIGHLIGHTS

- Upper made with printable and ultralight fabric.
- Viscose blend lining, light and breathable.
- Ultra light external laces.
- Oil and hydrocarbon resistant rubber thin sole with back spoiler.
- Flexible carbon insole for the best pedal feeling.
- Protective lateral insert sponge.



Transparent silicone reinforcement



**OPT CARBON**

For the best protection and stability during the race.



Real flexible carbon insole with differentiated areas.



**0012A9..BMRS**

**0012A9SP01**





**FIA APPROVED**

MANUFACTURER: SPARCO  
 MODEL: SUPERLEGGERA  
 HOM. NO: DC.309.23-Z  
 FIA STANDARD: 8856-2018

**HOMOLOGATION:** FIA 8856/2018 - SFI 3.3/5  
**WEIGHT:** 240 GR. (SIZE 42) **SIZES:** 37-48  
**CUSTOMIZATION:** ON DEMAND



**M. Verstappen**  
 Oracle Red Bull Racing Team  
 3 times F1 World Champion  
 2021/2022/2023

## HIGHLIGHTS

- Upper in printable fabric with transparent silicone reinforcements.
- Jacquard sock for maximum fit and breathability.
- External Lacing.
- Sole with extended rear spoiler to ensure support while driving.
- Carbon sole with differentiated areas.



Jacquard sock for maximum fit and breathability



For the best protection and stability during the race.



Real flexible carbon insole with differentiated areas.



0012A3..BINR

0012A3..NRRS

OPT CARBON

0012A3..NRGF

0012A3..NRBI

0012A3SP01

RACING	SHOES
RACING	HELMETS
RACING	SEATS
RACING	HARNESSES STEERING WHEELS
RACING	MECHANICS TECHNICAL
KARTING	SUITS UNDERWEAR
KARTING	SHOES / GLOVES PROTECTIONS
PERFORMANCE	SEATS HARNESSES STEERING WHEELS
e-SPORTS	SIM RACING CHAIRS
TEAMWEAR & LIFESTYLE	CLOTHING ACCESSORIES
TEAMWEAR & LIFESTYLE	CAPSULE COLLECTIONS
OUTLET	



**HOMOLOGATION:** FIA 8856-2018 - SFI 3.3/5  
**WEIGHT:** 200 GR. (SIZE 42) **SIZES:** 37-48  
**CUSTOMIZATION:** ON DEMAND

MANUFACTURER: SPARCO  
MODEL: PRIME EVO LITE  
HOM. NO: DC.372.23-Z  
FIA STANDARD: 8856-2018



## HIGHLIGHTS

- Upper made with printable and ultralight fabric.
- Light and breathable lining.
- Single-layer stretch jacquard on back insert and tongue.
- Ergonomic footbed.
- Padding on ankle area.
- Quick strap closure with ultra-flat perforated tape.
- Oil and hydrocarbon resistant rubber thin sole with back spoiler.
- Flexible carbon insole for the best pedal feeling.
- Protective lateral insert sponge.
- Transparent silicone reinforcement.



For the best protection and stability during the race.



Real flexible carbon insole with differentiated areas.



0012B1SP



0012B1SP01

RACING	SHOES
RACING	HELMETS
RACING	SEATS
RACING	HARNESSES STEERING WHEELS
RACING	MECHANICS TECHNICAL
KARTING	SUITS UNDERWEAR
KARTING	SHOES / GLOVES PROTECTIONS
PERFORMANCE	SEATS HARNESSES STEERING WHEELS
e-SPORTS	SIM RACING CHAIRS
TEAMWEAR & LIFESTYLE	CLOTHING ACCESSORIES
TEAMWEAR & LIFESTYLE	CAPSULE COLLECTIONS





**HOMOLOGATION:** FIA 8856-2018  
**WEIGHT:** 210 GR. (SIZE 42) **SIZES:** 37-48  
**CUSTOMIZATION:** ON DEMAND

MANUFACTURER: SPARCO  
 MODEL: PRIME EVO  
 HOM. NO: DC.206.22-Z  
 FIA STANDARD: 8856-2018



## HIGHLIGHTS

- Quick strap closure with ultra-flat perforated tape.
- Kangaroo leather upper with inkjet print.
- Breathable lining.
- Ergonomic footbed.
- Oil and hydrocarbon resistant rubber thin sole.



Single-layer stretch jacquard tongue.



Single-layer stretch jacquard.



Real flexible carbon sole with differentiated areas.



001297..BI



001297..RS



001297..GRGF



001297..BMRS



001297..NR

RACING	SHOES
RACING	HELMETS
RACING	SEATS
RACING	HARNESSES STEERING WHEELS
RACING	MECHANICS TECHNICAL
KARTING	SUITS UNDERWEAR
KARTING	SHOES / GLOVES PROTECTIONS
PERFORMANCE	SEATS HARNESSES STEERING WHEELS
e-SPORTS	SIM RACING CHAIRS
TEAMWEAR & LIFESTYLE	CLOTHING ACCESSORIES
TEAMWEAR & LIFESTYLE	CAPSULE COLLECTIONS
OUTLET	





**HOMOLOGATION:** FIA 8856-2018 - SFI 3.3/5 (ON DEMAND)  
**WEIGHT:** 220 GR. (SIZE 42) **SIZES:** 39-46  
**CUSTOMIZATION:** ON DEMAND

MANUFACTURER: SPARCO  
 MODEL: X-LIGHT +  
 HOM. NO: DC.076.20-Z  
 FIA STANDARD: 8856-2018



## HIGHLIGHTS

- Rollable ankle fabric with lace flap.
- Ultra-light external closure. Supplied with double laces.
- Jacquard uppers.
- Printed kangaroo leather.
- Thin rubber sole with differentiated grip zones.



Protective 3D texture.



High abrasion-resistant leather heel.



Real flexible carbon sole with differentiated areas.



001278..BINR



001278..NRGF



001278..NRAF



001278..NRRS



001278..NR

RACING	SHOES
RACING	HELMETS
RACING	SEATS
RACING	HARNESSES STEERING WHEELS
RACING	MECHANICS TECHNICAL
KARTING	SUITS UNDERWEAR
KARTING	SHOES / GLOVES PROTECTIONS
PERFORMANCE	SEATS HARNESSES STEERING WHEELS
e-SPORTS	SIM RACING CHAIRS
TEAMWEAR & LIFESTYLE	CLOTHING ACCESSORIES
TEAMWEAR & LIFESTYLE	CAPSULE COLLECTIONS
OUTLET	



**HOMOLOGATION:** FIA 8856-2018 - (SFI 3.3/5 ON DEMAND)  
**WEIGHT:** 260 GR. (SIZE 42) **SIZES:** 37-48  
**CUSTOMIZATION:** ON DEMAND

MANUFACTURER: SPARCO  
MODEL: X-LIGHT  
HOM. NO: DC.059.19-Z  
FIA STANDARD: 8856-2018



## HIGHLIGHTS

- Flat, light glossy laces.
- Elasticated jaquard rear insert.
- Strong and ultra-light Kevlar loops.
- Silkscreen printed tumbled calfskin uppers.
- Perforations for maximum breathability.
- Comfortable insole.
- TPU FR sole with differentiated grip texture.



Rollable jaquard tongue with lace flap.



High abrasion-resistant leather inserts.



001283..BIRS



001283..NRGF



001283..GRAF



001283..NRGR

RACING	SHOES
RACING	HELMETS
RACING	SEATS
RACING	HARNESSES STEERING WHEELS
RACING	MECHANICS TECHNICAL
KARTING	SUITS UNDERWEAR
KARTING	SHOES / GLOVES PROTECTIONS
PERFORMANCE	SEATS HARNESSES STEERING WHEELS
e-SPORTS	SIM RACING CHAIRS
TEAMWEAR & LIFESTYLE	CLOTHING ACCESSORIES
TEAMWEAR & LIFESTYLE	CAPSULE COLLECTIONS
OUTLET	



**HOMOLOGATION:** FIA 8856-2018 - SFI 3.3/5  
**WEIGHT:** 300 GR. (SIZE 42)  
**SIZES:** 37-48 (32-34-36-49-50 ON DEMAND)  
**CUSTOMIZATION:** ON DEMAND

**FIA APPROVED**  
 MANUFACTURER: SPARCO  
 MODEL: FORMULA  
 HOM. NO: DC.179.21-Z  
 FIA STANDARD: 8856-2018



## HIGHLIGHTS

- Tumbled calfskin uppers silkscreen printed.
- Adjustable strap with ultra-flat tape.
- Breathable lining.
- Single-layer stretch jacquard back insert.
- Foam footbed.
- Oil and hydrocarbon resistant rubber sole.



Quick lacing system.



Perforations for maximum breathability.



001296..BINR



001296..BXBI



001296..NRBI



001296..NRRS

RACING	SHOES
RACING	HELMETS
RACING	SEATS
RACING	HARNESSES STEERING WHEELS
RACING	MECHANICS TECHNICAL
KARTING	SUITS UNDERWEAR
KARTING	SHOES / GLOVES PROTECTIONS
PERFORMANCE	SEATS HARNESSES STEERING WHEELS
e-SPORTS	SIM RACING CHAIRS
TEAMWEAR & LIFESTYLE	CLOTHING ACCESSORIES
TEAMWEAR & LIFESTYLE	CAPSULE COLLECTIONS
OUTLET	



**HOMOLOGATION:** FIA 8856-2018 - SFI 3.3/5  
**WEIGHT:** 310 GR. (SIZE 42) **SIZES:** 37-48  
**CUSTOMIZATION:** ON DEMAND

MANUFACTURER: SPARCO  
MODEL: SKID  
HOM. NO: DC.047.19-Z  
FIA STANDARD: 8856-2018



## HIGHLIGHTS

- Elasticated rear insert.
- Breathable lining.
- Comfortable insole.
- TPU FR sole with differentiated grip texture.



Overlap tongue integrated with side.

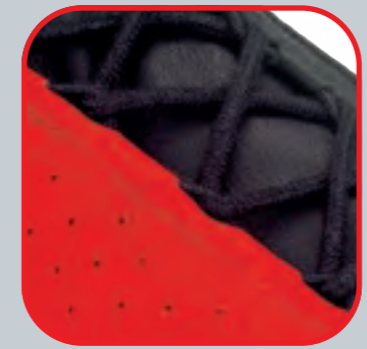

Ultra resistant Kevlar loops.



001275..BIBI



001275..RSNR



001275..BNBI



001275..NRNR

RACING	SHOES
RACING	HELMETS
RACING	SEATS
RACING	HARNESSES STEERING WHEELS
RACING	MECHANICS TECHNICAL
KARTING	SUITS UNDERWEAR
KARTING	SHOES / GLOVES PROTECTIONS
PERFORMANCE	SEATS HARNESSES STEERING WHEELS
e-SPORTS	SIM RACING CHAIRS
TEAMWEAR & LIFESTYLE	CLOTHING ACCESSORIES
TEAMWEAR & LIFESTYLE	CAPSULE COLLECTIONS
OUTLET	



NEW



**HOMOLOGATION:** FIA 8856-2018 - SFI 3.3/5  
**WEIGHT:** 490 GR. (SIZE 42) **SIZES:** 38-48  
**CUSTOMIZATION:** ON DEMAND

MANUFACTURER: SPARCO  
MODEL: 12B2  
HOM. NO: DC.375.23-Z  
FIA STANDARD: 8856-2018



## HIGHLIGHTS

- Upper made of tumbled leather with perforated areas and suede reinforcement inserts.
- Breathable and fresh lining.
- Shock-absorber footbed.
- Strap on ankle.
- Rubber and phylon sole for maximum grip and comfort.



Quick closing system with lateral rotor and high-strength steel cable.



Reflective prints for maximum safety in all visibility conditions.



0012B2..NRNR



0012B2..NRRS

RACING	SHOES
RACING	HELMETS
RACING	SEATS
RACING	HARNESSES STEERING WHEELS
RACING	MECHANICS TECHNICAL
KARTING	SUITS UNDERWEAR
KARTING	SHOES / GLOVES PROTECTIONS
PERFORMANCE	SEATS HARNESSES STEERING WHEELS
e-SPORTS	SIM RACING CHAIRS
TEAMWEAR & LIFESTYLE	CLOTHING ACCESSORIES
TEAMWEAR & LIFESTYLE	CAPSULE COLLECTIONS
OUTLET	



**HOMOLOGATION:** FIA 8856-2018  
**WEIGHT:** 385 GR. (SIZE 42) **SIZES:** 37-48  
**CUSTOMIZATION:** ON DEMAND

MANUFACTURER: SPARCO  
MODEL: TOP  
HOM. NO: DC.102.20-Z  
FIA STANDARD: 8856-2018



## HIGHLIGHTS

- Breathable lining.
- Embroidered Logos.
- Natural leather insole.
- Oil and hydrocarbon resistant rubber sole.



Adjustable ultra-flat strap.



Suede with smooth leather inserts.



001287..RS



001287..BRFX



001287..NR

RACING	SHOES
RACING	HELMETS
RACING	SEATS
RACING	HARNESSES STEERING WHEELS
RACING	MECHANICS TECHNICAL
KARTING	SUITS UNDERWEAR
KARTING	SHOES / GLOVES PROTECTIONS
PERFORMANCE	SEATS HARNESSES STEERING WHEELS
e-SPORTS	SIM RACING CHAIRS
TEAMWEAR & LIFESTYLE	CLOTHING ACCESSORIES
TEAMWEAR & LIFESTYLE	CAPSULE COLLECTIONS
OUTLET	





# FUTURA



**HOMOLOGATION:** FIA 8856/2018 - SFI 3.3/5  
**WEIGHT:** 420 GR. (SIZE 42) **SIZES:** 36-48  
**CUSTOMIZATION:** ON DEMAND

MANUFACTURER: SPARCO  
 MODEL: FUTURA  
 HOM. NO: DC.288.22-Z  
 FIA STANDARD: 8856-2018



## HIGHLIGHTS

- Super-breathable upper in FULL EFFICIENCY black melange fabric.
- Sole with excellent grip.
- Comfortable and suitable for track-day.



Sparco® FULL EFFICIENCY fabric.



Three-dimensional knit lining built with FULL EFFICIENCY yarn.



FULL EFFICIENCY zero-waste shoes bag included.



0012A4..GRVF



0012A4..GRBI



- LCA (Life Cycle Assessment) certified.
- 39% REDUCTION of the impact on climate change.\*
- 80% of regenerated fibers (on upper).
- ZERO WASTE.\*\*

\*Value to be compared to a traditional production. The reduction equals the amount of CO2 released into the environment traveling approx. 50 km by car.  
 \*\*Target achieved through the regeneration of the fibers used in mass production.

RACING	SHOES
RACING	HELMETS
RACING	SEATS
RACING	HARNESSES STEERING WHEELS
RACING	MECHANICS TECHNICAL
KARTING	SUITS UNDERWEAR
KARTING	SHOES / GLOVES PROTECTIONS
PERFORMANCE	SEATS HARNESSES STEERING WHEELS
e-SPORTS	SIM RACING CHAIRS
TEAMWEAR & LIFESTYLE	CLOTHING ACCESSORIES
TEAMWEAR & LIFESTYLE	CAPSULE COLLECTIONS
OUTLET	



**HOMOLOGATION:** FIA 8856-2018 - SFI 3.3/5  
**WEIGHT:** 330 GR. (SIZE 42) **SIZES:** 35-48  
**YOUTH SIZES NR:** 28-30-32-34 (ON DEMAND)

MANUFACTURER: SPARCO  
 MODEL: SLALOM +  
 HOM. NO: DC.037.19-Z  
 FIA STANDARD: 8856-2018



## HIGHLIGHTS

- Perforated suede leather uppers.
- Breathable lining.
- Perforated tongue.
- Comfortable insole.
- Oil and hydrocarbon resistant rubber sole with differentiated grip zones.



Reinforced toe.



High abrasion-resistant reinforced leather heel.



001274..RS

001274..BRFX

001274..NR

RACING	SHOES
RACING	HELMETS
RACING	SEATS
RACING	HARNESSES STEERING WHEELS
RACING	MECHANICS TECHNICAL
KARTING	SUITS UNDERWEAR
KARTING	SHOES / GLOVES PROTECTIONS
PERFORMANCE	SEATS HARNESSES STEERING WHEELS
e-SPORTS	SIM RACING CHAIRS
TEAMWEAR & LIFESTYLE	CLOTHING ACCESSORIES
TEAMWEAR & LIFESTYLE	CAPSULE COLLECTIONS
OUTLET	



**HOMOLOGATION:** FIA 8856-2018 - SFI 3.3/5  
**WEIGHT:** 350 GR. (SIZE 42)  
**SIZES:** 36-48

MANUFACTURER: SPARCO  
MODEL: SLALOM  
HOM. NO: DC.164.21-Z  
FIA STANDARD: 8856-2018



## HIGHLIGHTS

- Embroidered Logos.
- Side leather insert with printed logo.
- High resistance glossy round laces.
- Leather insole.
- Oil and hydrocarbon resistant rubber sole.



Embroidered suede leather uppers.



Fabric back insert.



RACING	SHOES
RACING	HELMETS
RACING	SEATS
RACING	HARNESSES STEERING WHEELS
RACING	MECHANICS TECHNICAL
KARTING	SUITS UNDERWEAR
KARTING	SHOES / GLOVES PROTECTIONS
PERFORMANCE	SEATS HARNESSES STEERING WHEELS
e-SPORTS	SIM RACING CHAIRS
TEAMWEAR & LIFESTYLE	CLOTHING ACCESSORIES
TEAMWEAR & LIFESTYLE	CAPSULE COLLECTIONS
OUTLET	



# DAVINI GLOVES RACING



OUTLET

TEAMWEAR & LIFESTYLE  
CAPSULE COLLECTIONS

TEAMWEAR & LIFESTYLE  
CLOTHING ACCESSORIES

e-SPORTS  
SIM RACING CHAIRS

PERFORMANCE  
SEATS  
HARNESSES  
STEERING WHEELS

KARTING  
SHOES / GLOVES  
PROTECTIONS

KARTING  
SUITS  
UNDERWEAR

RACING  
MECHANICS  
TECHNICAL

RACING  
HARNESSES  
STEERING WHEELS

RACING  
SEATS

RACING  
HELMETS

RACING  
GLOVES



## TIDE

**HOMOLOGATION:** FIA 8856-2018 - SFI 3.3/5  
**PALM COMPOSITION:** HTX - VULCANO  
**PRECURVED:** YES  
**SEAMS:** EXTERNAL  
**SIZES:** 8-13  
**CUSTOMIZATION:** ON DEMAND



## ARROW+ **NEW**

**HOMOLOGATION:** FIA 8856-2018 NEW REQUIREMENTS COMPLIANT - SFI 3.3/5  
**PALM COMPOSITION:** HTX - FLAT  
**PRECURVED:** YES  
**SEAMS:** EXTERNAL (NO THUMBS)  
**SIZES:** 7-13  
**CUSTOMIZATION:** ON DEMAND



## ARROW

**HOMOLOGATION:** FIA 8856-2018 - SFI 3.3/5  
**PALM COMPOSITION:** HTX - FLAT  
**PRECURVED:** YES  
**SEAMS:** EXTERNAL (NO THUMBS)  
**SIZES:** 7-13  
**CUSTOMIZATION:** ON DEMAND



## LAP

**HOMOLOGATION:** FIA 8856-2018 NEW REQUIREMENTS COMPLIANT - SFI 3.3/5  
**PALM COMPOSITION:** SILICONE  
**PRECURVED:** YES  
**SEAMS:** MIXED  
**SIZES:** 7-13  
**CUSTOMIZATION:** ON DEMAND

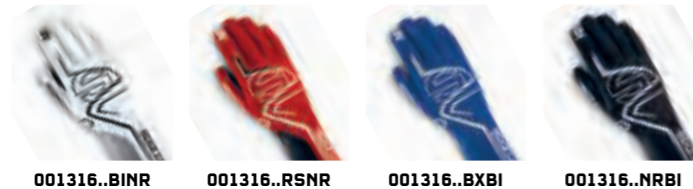

## FUTURA

**HOMOLOGATION:** FIA 8856-2018 NEW REQUIREMENTS COMPLIANT - SFI 3.3/5  
**PALM COMPOSITION:** SILICONE  
**PRECURVED:** NOT  
**SEAMS:** MIXED  
**SIZES:** 8-13 **CUSTOMIZATION:** ON DEMAND



## LAND+

**HOMOLOGATION:** FIA 8856-2018 - SFI 3.3/5  
**PALM COMPOSITION:** SILICONE  
**PRECURVED:** NOT  
**SEAMS:** INTERNAL  
**SIZES:** 8-13  
**CUSTOMIZATION:** ON DEMAND



## LAND

**HOMOLOGATION:** FIA 8856-2018 - SFI 3.3/5  
**PALM COMPOSITION:** SUEDE  
**PRECURVED:** NOT  
**SEAMS:** INTERNAL  
**SIZES:** 8-13 / 4 AND 6 ON DEMAND  
**CUSTOMIZATION:** ON DEMAND



## LAND CLASSIC

**HOMOLOGATION:** FIA 8856-2018 - SFI 3.3/5  
**PALM COMPOSITION:** SUEDE  
**PRECURVED:** NOT  
**SEAMS:** INTERNAL  
**SIZES:** 8-13  
**CUSTOMIZATION:** FROM STOCK







**HOMOLOGATION:** FIA 8856-2018 - SFI 3.3/5 **SIZES:** 8-13  
**CUSTOMIZATION:** ON DEMAND

MANUFACTURER: SPARCO  
MODEL: TIDE  
HOM. NO: DC.032.19-G  
FIA STANDARD: 8856-2018



## HIGHLIGHTS

- Precurved glove.
- Aramid jersey fabric.
- Thumb joined to back.
- External seams.
- Touch-S on index finger and thumb.
- Internal wrist stitching.

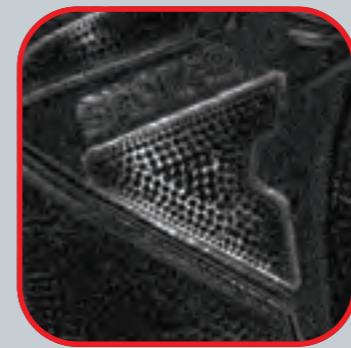

HTX 3D Volcano palm with differentiated zones.



Ergonomic seam on thumb.



001356..BINR



001356..RSNR



001356..AZBI



001356..NRRS

RACING	GLOVES
RACING	HELMETS
RACING	SEATS
RACING	HARNESSES STEERING WHEELS
RACING	MECHANICS TECHNICAL
KARTING	SUITS UNDERWEAR
KARTING	SHOES / GLOVES PROTECTIONS
PERFORMANCE	SEATS HARNESSES STEERING WHEELS
e-SPORTS	SIM RACING CHAIRS
TEAMWEAR & LIFESTYLE	CLOTHING ACCESSORIES
TEAMWEAR & LIFESTYLE	CAPSULE COLLECTIONS
OUTLET	





**HOMOLOGATION:** FIA 8856/2018 - SFI 3.3/5  
**SIZES:** 7-13 **CUSTOMIZATION:** ON DEMAND

MANUFACTURER: SPARCO  
 MODEL: ARROW+  
 HOM. NO: DC.301.23-G  
 FIA STANDARD: 8856-2018



## HIGHLIGHTS

- Precurved glove.
- Ergonomic stitching on the thumb.
- External seams on the fingers.
- HTX flat palm.
- Touch-S on index finger and thumb.



HTX flat palm.



Touch-S on index finger and thumb.

Compliant to the new FIA 8856-2018 heat transmission requirements.



001319..NRBI



001319..BINR

RACING	GLOVES
RACING	HELMETS
RACING	SEATS
RACING	HARNESSES STEERING WHEELS
RACING	MECHANICS TECHNICAL
KARTING	SUITS UNDERWEAR
KARTING	SHOES / GLOVES PROTECTIONS
PERFORMANCE	SEATS HARNESSES STEERING WHEELS
e-SPORTS	SIM RACING CHAIRS
TEAMWEAR & LIFESTYLE	CLOTHING ACCESSORIES
TEAMWEAR & LIFESTYLE	CAPSULE COLLECTIONS
OUTLET	





**HOMOLOGATION:** FIA 8856-2018 - SFI 3.3/5 **SIZES:** 7-13  
**CUSTOMIZATION:** ON DEMAND

MANUFACTURER: SPARCO  
MODEL: ARROW  
HOM. NO: DC.014.19-G  
FIA STANDARD: 8856-2018



## HIGHLIGHTS

- Precurved glove.
- Ergonomic seam on thumb.
- Aramid jersey fabric.
- External seams.



HTX flat palm.



Touch-S on index finger and thumb.



001314..BINR



001314..GFNR



001314..RSNR



001314..BMRS



001314..AFNR



001314..NRBI

RACING	GLOVES
RACING	HELMETS
RACING	SEATS
RACING	HARNESSES STEERING WHEELS
RACING	MECHANICS TECHNICAL
KARTING	SUITS UNDERWEAR
KARTING	SHOES / GLOVES PROTECTIONS
PERFORMANCE	SEATS HARNESSES STEERING WHEELS
e-SPORTS	SIM RACING CHAIRS
TEAMWEAR & LIFESTYLE	CLOTHING ACCESSORIES
TEAMWEAR & LIFESTYLE	CAPSULE COLLECTIONS
OUTLET	





**HOMOLOGATION:** FIA 8856-2018 - SFI 3.3/5 **SIZES:** 7-13  
**CUSTOMIZATION:** ON DEMAND

MANUFACTURER: SPARCO  
MODEL: LAP V02  
HOM. NO: DC.361.23-G  
FIA STANDARD: 8856-2018



## HIGHLIGHTS

- Differentiated external and internal stitching on fingers.
- External stitching on thumb.
- Back joined with the thumb.



New silicone palm for maximum grip on the wheel.



Single-layer stretch wrist insert



Best matching with the new Competition seamless elastic sleeves.

Compliant to the new FIA 8856-2018 heat transmission requirements.



001316..BINR



001316..RSNR



001316..BXBI



001316..NRBI

RACING	GLOVES
RACING	HELMETS
RACING	SEATS
RACING	HARNESSES STEERING WHEELS
RACING	MECHANICS TECHNICAL
KARTING	SUITS UNDERWEAR
KARTING	SHOES / GLOVES PROTECTIONS
PERFORMANCE	SEATS HARNESSES STEERING WHEELS
e-SPORTS	SIM RACING CHAIRS
TEAMWEAR & LIFESTYLE	CLOTHING ACCESSORIES
TEAMWEAR & LIFESTYLE	CAPSULE COLLECTIONS
OUTLET	





# FUTURA



**HOMOLOGATION:** FIA 8856-2018 - SFI 3.3/5 **SIZES:** 8-13  
**CUSTOMIZATION:** ON DEMAND

MANUFACTURER: SPARCO  
MODEL: FUTURA  
HOM. NO: DC.317.23-G  
FIA STANDARD: 8856-2018



## HIGHLIGHTS

- Palm with external seams and fingers with internal seams for maximum comfort.
- Straight cut cuff.



Full Efficiency three-dimensional knit lining.



Silicon palm to ensure maximum grip on the steering wheel.

Compliant to the new FIA 8856-2018 heat transmission requirements.



001365..BINR



FULL EFFICIENCY zero-waste gloves bag included.



001365..NRGF



001365..NRVF



001365..NRBI



- VIRTUOUS CIRCULAR PRODUCTION CYCLE
- ZERO WASTE TARGET
- MORE THAN 51% OF REGENERATED FIBERS
- FULLY OWNED TECHNOLOGY

RACING	GLOVES
RACING	HELMETS
RACING	SEATS
RACING	HARNESSES STEERING WHEELS
RACING	MECHANICS TECHNICAL
KARTING	SUITS UNDERWEAR
KARTING	SHOES / GLOVES PROTECTIONS
PERFORMANCE	SEATS HARNESSES STEERING WHEELS
e-SPORTS	SIM RACING CHAIRS
TEAMWEAR & LIFESTYLE	CLOTHING ACCESSORIES
TEAMWEAR & LIFESTYLE	CAPSULE COLLECTIONS
OUTLET	





**HOMOLOGATION:** FIA 8856-2018 - SFI 3.3/5 **SIZES:** 8-13  
**CUSTOMIZATION:** ON DEMAND

MANUFACTURER: SPARCO  
MODEL: LAND+  
HOM. NO: DC.104.20-G  
FIA STANDARD: 8856-2018



## HIGHLIGHTS

- Internal seams.
- Palm joined with thumb.



Palm with silicone inserts.



Printed graphics.



Straight cut cuff.



001362..GF



001362..RS



001362..EB



001362..NR

RACING	GLOVES
RACING	HELMETS
RACING	SEATS
RACING	HARNESSES STEERING WHEELS
RACING	MECHANICS TECHNICAL
KARTING	SUITS UNDERWEAR
KARTING	SHOES / GLOVES PROTECTIONS
PERFORMANCE	SEATS HARNESSES STEERING WHEELS
e-SPORTS	SIM RACING CHAIRS
TEAMWEAR & LIFESTYLE	CLOTHING ACCESSORIES
TEAMWEAR & LIFESTYLE	CAPSULE COLLECTIONS
OUTLET	



**HOMOLOGATION:** FIA 8856-2018 - SFI 3.3/5  
**SIZES:** 8-13 / 4 AND 6 ON DEMAND  
**CUSTOMIZATION:** ON DEMAND

MANUFACTURER: SPARCO  
MODEL: LAND  
HOM. NO: DC.170.21-G  
FIA STANDARD: 8856-2018



## HIGHLIGHTS

- Straight cut cuff.
- Internal seams.



Printed graphics.



Palm with suede inserts.



Elastic on wrist.



001363..GF



001363..RS



001363..EB



001363..NR

RACING	GLOVES
RACING	HELMETS
RACING	SEATS
RACING	HARNESSES STEERING WHEELS
RACING	MECHANICS TECHNICAL
KARTING	SUITS UNDERWEAR
KARTING	SHOES / GLOVES PROTECTIONS
PERFORMANCE	SEATS HARNESSES STEERING WHEELS
e-SPORTS	SIM RACING CHAIRS
TEAMWEAR & LIFESTYLE	CLOTHING ACCESSORIES
TEAMWEAR & LIFESTYLE	CAPSULE COLLECTIONS
OUTLET	



**HOMOLOGATION:** FIA 8856-2018 - SFI 3.3/5  
**SIZES:** 8-13 **CUSTOMIZATION:** FROM STOCK

MANUFACTURER: SPARCO  
MODEL: LAND  
HOM. NO: DC.170.21-G  
FIA STANDARD: 8856-2018



## HIGHLIGHTS

- Internal seams.
- New back with Sparco patch.



Patch with embroidered Sparco Logo.



Palm with suede inserts.



Straight cut cuff.



001364..EC



001364..BM

RACING	GLOVES
RACING	HELMETS
RACING	SEATS
RACING	HARNESSES STEERING WHEELS
RACING	MECHANICS TECHNICAL
KARTING	SUITS UNDERWEAR
KARTING	SHOES / GLOVES PROTECTIONS
PERFORMANCE	SEATS HARNESSES STEERING WHEELS
e-SPORTS	SIM RACING CHAIRS
TEAMWEAR & LIFESTYLE	CLOTHING ACCESSORIES
TEAMWEAR & LIFESTYLE	CAPSULE COLLECTIONS
OUTLET	



# D R A P I N G H E L M E T S K A R T I N G



OUTLET	TEAMWEAR & LIFESTYLE	TEAMWEAR & LIFESTYLE	e-SPORTS	PERFORMANCE	KARTING	KARTING	RACING	RACING	RACING	RACING
	CAPSULE COLLECTIONS	CLOTHING ACCESSORIES	SIM RACING CHAIRS	SEATS HARNESSES STEERING WHEELS	SHOES / GLOVES PROTECTIONS	SUITS UNDERWEAR	MECHANICS TECHNICAL	HARNESSES STEERING WHEELS	SEATS	HELMETS



MADE IN ITALY

OPEN FACE HELMETS WITH INTERCOM

OPEN FACE HELMETS

FIA 8860-2018 / SNELL SA 2020

### PRIME RJ-i SUPERCARBON 8860-2018

**HOMOLOGATION:** FIA 8860-2018  
**MATERIAL:** HIGH TENSILE CARBON FIBER - HANS® CLIPS  
**SIZES:** XS-XL



003372ZRS



003372ZNR

FIA 8859-2015 / SNELL SA 2020

### RJ-i CARBON

**HOMOLOGATION:** FIA 8859-2015 SNELL SA 2020  
**MATERIAL:** CARBON - HANS® CLIPS  
**SIZES:** XS-XL



003371ZRS



003371ZNR

### RJ-i

**HOMOLOGATION:** FIA 8859-2015 SNELL SA 2020  
**MATERIAL:** FIBERGLASS / CARBON-KEVLAR - HANS® CLIPS  
**SIZES:** XS-XXL



003369BIRS



003369BI



003369NRRS



003369NR

FIA 8859-2015 / SNELL SA 2020

### RJ

**HOMOLOGATION:** FIA 8859-2015 SNELL SA 2020  
**MATERIAL:** FIBERGLASS / CARBON-KEVLAR - HANS® CLIPS  
**SIZES:** XS-XXL



003370BI

ECE 22-06

### J-PRO NEW

**HOMOLOGATION:** ECE 22-06  
**MATERIAL:** SHELL COMPLYING WITH THE NEW ECE 22-06 STANDARD  
**SIZES:** S-XXL



003379BI..



003379NR..

FULL FACE HELMETS

FIA 8860-2018 / SNELL SA 2020

### PRIME RF-10W SUPERCARBON 8860-2018

**HOMOLOGATION:** FIA 8860-2018 ABP - FIA 8860-2018 / SNELL SA 2020  
**MATERIAL:** HIGH TENSILE CARBON FIBER - HANS® CLIPS  
**SIZES:** XS-XL



003373ZSP



003373ZNR



003373ZRS

FIA 8859-2015 / SNELL SA 2020

### SKY RF-7W CARBON

**HOMOLOGATION:** FIA 8859-2015 SNELL SA 2020  
**MATERIAL:** CARBON - HANS® CLIPS  
**SIZES:** XS-XL



003374ZRS



003374ZNR

### AIR PRO RF-5W

**HOMOLOGATION:** FIA 8859-2015 SNELL SA 2020  
**MATERIAL:** FIBERGLASS / CARBON-KEVLAR - HANS® CLIPS  
**SIZES:** XS-XXL



003375BIRS



003375BI



003375NRRS



003375ZNR

ECE 22-06

### X-PRO NEW

**HOMOLOGATION:** ECE 22-06  
**MATERIAL:** SHELL COMPLYING WITH THE NEW ECE 22-06 STANDARD  
**SIZES:** S-XXL



003378BI..



003378NR..

RACING	HELMETS
RACING	SEATS
RACING	HARNESSES STEERING WHEELS
RACING	MECHANICS TECHNICAL
KARTING	SUITS UNDERWEAR
KARTING	SHOES / GLOVES PROTECTIONS
PERFORMANCE	SEATS HARNESSES STEERING WHEELS
e-SPORTS	SIM RACING CHAIRS
TEAMWEAR & LIFESTYLE	CLOTHING ACCESSORIES
TEAMWEAR & LIFESTYLE	CAPSULE COLLECTIONS
OUTLET	





MANUFACTURER: SPARCO  
MODEL: Prime RJ-i Supercarbon  
HOM. NO: AH.022.22-O  
FIA STANDARD: 8860-2018

HOMOLOGATION: FIA 8860-2018  
SIZES: XS-XL

**A. Crugnola**  
Winner of the Italian Sparco  
Rally Championship 2023



## HIGHLIGHTS

- High tensile carbon fiber shell.
- Double-sized shell and polystyrene with vents.
- New breathable fire retardant jersey available in different colour options.
- Ergonomic variable padding density.
- Military type connection through female Nexus integrated in the shell.
- New electronics with the adoption of earphones.
- Hans® clip.



Peak with removable insert for the installing of the adjustable sun visor.



Integrated microphone cover and semi-rigid arm with reduced bulk for easy adjustment and maximum visibility.



- Customizable, removable and washable interior.



003372ZRS..

003372ZNR..

### RJ-i SUPERCARBON

XS	53-54	003372Z..0XS
S	55-56	003372Z..1S
M	57-58	003372Z..2M
M+	59	003372Z..3ML
L	60	003372Z..4L
XL	61	003372Z..5XL

### OPTIONAL VISORS P. 114



00314V11



00314V14



00314V15





MANUFACTURER: VM SAFETY  
MODEL: SPARCO SKY RJ-7  
HOM. NO: PH.041.16-O  
FIA STANDARD: 8859-2015

**HOMOLOGATION:** FIA 8859-2015 / SNELL SA 2020  
**SIZES:** XS-XL

**B. Bulacia**  
WRC2 driver



## HIGHLIGHTS

- Double-sized shell and polystyrene with vents.
- Pre-preg carbon fibre shell reinforced with carbon-kevlar layers.
- New breathable fireproof jersey available in different colour options.
- Military type connection through male Nexus (die-cast Nexus connector).
- Clip Hans®.



New peak design optimized for sun protection.



New intercom system with ear cups and noise canceling microphone.



CARBON		
XS	53-54	003371ZNR0XS
S	55-56	003371ZNR1S
M	57-58	003371ZNR2M
M+	59	003371ZNR3ML
L	60	003371ZNR4L
XL	61	003371ZNR5XL

### PEAK + VISORS OPTIONAL P. 115



003192

+



00304V01

00304V02

00304V03





**HIGHLIGHTS**

- Double-sized shell and polystyrene with vents.
- Fiberglass shell reinforced with carbon-kevlar.
- New breathable fireproof jersey available in different colour options.
- Adjustable and washable interior.
- New peak design optimised for sun protection.
- New intercom system with ear cups and noise canceling microphone.
- Military type connection through male Nexus (die-cast Nexus connector).
- Hans® clip.



**HIGHLIGHTS**

- Double-sized shell and polystyrene with vents.
- Fibreglass shell reinforced with carbon-kevlar.
- New breathable fireproof jersey.
- Adjustable and washable interior
- New peak design optimised for sun protection.
- Hans® clip.



RJ-i		
XS	53-54	003369..0XS
S	55-56	003369..1S
M	57-58	003369..2M
M+	59	003369..3ML
L	60	003369..4L
XL	61	003369..5XL
XXL	62	003369..6XXL



**PEAK / VISOR OPTIONAL** PG. 115



RJ		
XS	53-54	003370BI0XS
S	55-56	003370BI1S
M	57-58	003370BI2M
M+	59	003370BI3ML
L	60	003370BI4L
XL	61	003370BI5XL
XXL	62	003370BI6XXL





# PRIME RF-10W SUPERCARBON

8860-2018



**HOMOLOGATION:** FIA 8860-2018 ABP - FIA 8860-2018  
**SNELL SA 2020 SIZES:** XS-XL

MANUFACTURER: SPARCO  
MODEL: PRIME RF-10W SUPERCARBON  
HOM. NO: AH.024.23-C  
FIA STANDARD: 8860-2018

A. Di Folco  
Boutsen VDS  
GT World Challenge



## HIGHLIGHTS

- ABP (Advanced Ballistic Protection), the Ultimate Safety Standard.
- Double-sized shell and polystyrene with vents.
- Stronger protection into the upper part of the helmet shell.
- Customizable, removable and washable interior.
- Ergonomic variable padding density.
- Ready for drink system.
- FIA homologated visor with 3 positions adjustment.
- Hans® clip.

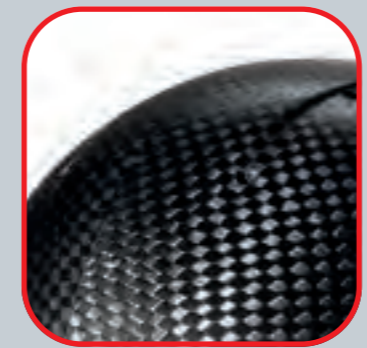

High tensile carbon fiber shell.



ABP (Advanced Ballistic Protection).

### FIA 8860-2018



SUPERCARBON		
XS	53-54	003373Z..0XS
S	55-56	003373Z..1S
M	57-58	003373Z..2M
M+	59	003373Z..3ML
L	60	003373Z..4L
XL	61	003373Z..5XL

### FIA 8860-2018 ABP (ADVANCED BALLISTIC PROTECTION)



SUPERCARBON - ABP		
XS	53-54	003376ZSP0XS
S	55-56	003376ZSP1S
M	57-58	003376ZSP2M
M+	59	003376ZSP3ML
L	60	003376ZSP4L
XL	61	003376ZSP5XL

### OPTIONAL VISORS

P. 116





# SKY

## RF-7W CARBON

HOMOLOGATION: FIA 8859-2015 / SNELL SA 2020  
SIZES: XS-XXL

 **APPROVED**

MANUFACTURER: VM SAFETY  
MODEL: SPARCO SKY RF-7W  
HOM. NO: PH.036.16-C  
FIA STANDARD: 8859-2015

# AIR PRO

## RF-5W

HOMOLOGATION: FIA 8859-2015 / SNELL SA 2020  
SIZES: XS-XXL

 **APPROVED**

MANUFACTURER: VM SAFETY  
MODEL: SPARCO AIR RF-5W  
HOM. NO: PH.037.16-C  
FIA STANDARD: 8859-2015

### HIGHLIGHTS

- Double-sized shell and polystyrene with vents.
- Carbon Fiber shell reinforced with carbon-kevlar.
- New breathable fireproof jersey available in different colour options.
- Adjustable and washable interior.
- Drink System Ready.
- FIA homologated visor with continuous adjustment.
- Hans® clip.



### HIGHLIGHTS

- Double-sized shell and polystyrene with vents.
- Fiberglass shell reinforced with carbon-kevlar.
- New breathable fireproof jersey available in different colour options.
- Adjustable and washable interior.
- Drink System Ready.
- FIA homologated visor with continuous adjustment.
- Hans® clip.



CARBON		
XS	53-54	003374Z0XS
S	55-56	003374Z1S
M	57-58	003374Z2M
M+	59	003374Z3ML
L	60	003374Z4L
XL	61	003374Z5XL
XXL	62	003374Z6XXL



OPTIONAL VISORS [P. 117](#)

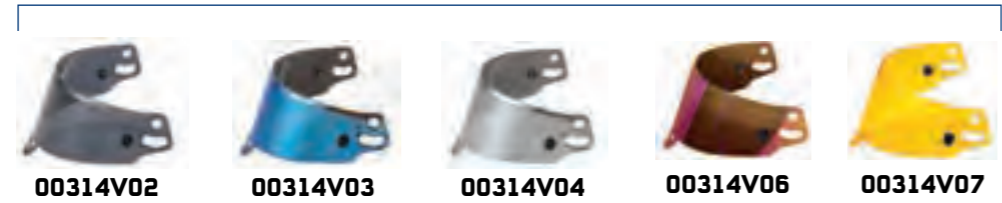

RF-5W		
XS	53-54	003375.0XS
S	55-56	003375.1S
M	57-58	003375.2M
M+	59	003375.3ML
L	60	003375.4L
XL	61	003375.5XL
XXL	62	003375.6XXL



OPTIONAL VISORS [P. 117](#)





# X-PRO



NEW

ECE 22-06

HOMOLOGATION: ECE 22-06

SIZES: S-XXL

# J-PRO



NEW

ECE 22-06

HOMOLOGATION: ECE 22-06

SIZES: S-XXL

## HIGHLIGHTS

- Shell complying with the new ECE 22-06 standard
- Hypoallergenic comfort lining material.
- Helmet suitable for kart hire and track days.



Dark visor optional  
**0032PROV01.**



## HIGHLIGHTS

- Shell complying with the new ECE 22-06 standard.
- Hypoallergenic comfort lining material.
- Helmet suitable for track day.
- Supplied with sun peak.



MATT BLACK		
S	55-56	003378NR1S
M	57-58	003378NR2M
L	59-60	003378NR3L
XL	61-62	003378NR4XL
XXL	63-64	003378NR5XXL



**003378NR..**

WHITE		
S	55-56	003378BI1S
M	57-58	003378BI2M
L	59-60	003378BI3L
XL	61-62	003378BI4XL
XXL	63-64	003378BI5XXL



**003378BI..**

MATT BLACK		
S	55-56	003379NR1S
M	57-58	003379NR2M
L	59-60	003379NR3L
XL	61-62	003379NR4XL
XXL	63-64	003379NR5XXL



**003379NR..**

WHITE		
S	55-56	003379BI1S
M	57-58	003379BI2M
L	59-60	003379BI3L
XL	61-62	003379BI4XL
XXL	63-64	003379BI5XXL



**003379BI..**



# OPEN FACE 8860-2018 HELMETS ACCESSORIES

# OPEN FACE 8859-2015 HELMETS ACCESSORIES

## PRIME RJ-i SUPERCARBON 8860-2018

003372Z..



## RJ-i CARBON

003371Z..



## RJ-i

003369..



## RJ

003370..



FIA 8860-2018 / SNELL SA 2020

FIA 8859-2015 / SNELL SA 2020

PEAKS/ SPARE PARTS

### CARBON NEW



00307Z

### KIT COVER + MICROPHONE CARBON NEW



00537043

### CARBON



00319Z

### BLACK



00319NR

### WHITE



00319BI

VISORS

### DARK



00314V11

### BLUE IRIDIUM NEW



00314V14

### RED IRIDIUM NEW



00314V15

PEAKS + VISORS KIT

### DARK

Fits only with 00319..



00304V01

### BLUE IRIDIUM

Fits only with 00319..



00304V02

### RED IRIDIUM

Fits only with 00319..



00304V03

PADDINGS

### TOP PADDING NEW



SIZES	BLACK	RED
XS	0032R02NR0XS	0032R02RS0XS
S	0032R02NR1S	0032R02RS1S
M	0032R02NR2M	0032R02RS2M
M+	0032R02NR3ML	0032R02RS3ML
L	0032R02NR4L	0032R02RS4L
XL	0032R02NR5XL	0032R02RS5XL

### CHEEK PADDING NEW



THICKNESS	BLACK	RED
20 mm	0032RJ03NR20	0032RJ03RS20
25 mm	0032RJ03NR25	0032RJ03RS25
30 mm	0032RJ03NR30	0032RJ03RS30
35 mm	0032RJ03NR35	0032RJ03RS35

### REMOVABLE CUPS NEW



00315K14

PEAKS

### CARBON

Not compatible with visors



00316F08

### NERO

Not compatible with visors



00316F06

### BIANCO

Not compatible with visors



00316F07

PADDINGS

### TOP PADDING



THICKNESS	BLACK
10 mm	0032R01XXL
15 mm	0032R01MMLXL
15+5 mm	0032R01XXS

### CHEEK PADDING



THICKNESS	BLACK	RED
25 mm	0032RJ02NR25	0032RJ02RS25
30 mm	0032RJ02NR30	0032RJ02RS30
35 mm	0032RJ02NR35	0032RJ02RS35

### REMOVABLE CUPS NEW



00315K14



# FULL FACE 8860-2018 HELMETS ACCESSORIES

# FULL FACE 8859-2015 HELMETS ACCESSORIES

## PRIME RF-10W SUPERCARBON 8860-2018

003373ZSP



## SKY RF-7W CARBON

003374Z..



## AIR PRO RF-5W

003375..



FIA 8860-2018 / SNELL SA 2020

FIA 8859-2015 / SNELL SA 2020

VISORS

### CLEAR



00314V08

### DARK



00314V09

### BLUE IRIDIUM NEW



00314V16

### RED IRIDIUM NEW



00314V17

### FASTENER KIT NEW



00315K13

### TOP PADDING NEW



SIZES	BLACK	RED
XS	0032R02NR0XS	0032R02RS0XS
S	0032R02NR1S	0032R02RS1S
M	0032R02NR2M	0032R02RS2M
M+	0032R02NR3ML	0032R02RS3ML
L	0032R02NR4L	0032R02RS4L
XL	0032R02NR5XL	0032R02RS5XL

### CHEEK PADDING NEW



THICKNESS	BLACK	RED
20 mm	0032RF03NR20	0032RF03RS20
25 mm	0032RF03NR25	0032RF03RS25
30 mm	0032RF03NR30	0032RF03RS30
35 mm	0032RF03NR35	0032RF03RS35

VISORS

### CLEAR



00314V01

### DARK



00314V02

### BLUE IRIDIUM



00314V03

### SILVER IRIDIUM



00314V04

### RED IRIDIUM

Not FIA compliant



00314V06

### YELLOW

Not FIA compliant



00314V07

### SET OF 5 TEAR OFFS



00315K01

### FASTENER KIT



00315K02

AIR INTAKES

### FRONT SPOILER

■ 00315K08



□ 00315K07



### REAR SPOILER

■ 00315K10



□ 00315K09



### CENTRAL AIR INTAKES

■ 00315K03



□ 0032WTXK04



### LATERAL AIR INTAKES

■ 00315K04



□ 0032WTXK06



### PUMPER

XS-M/L ■ 00317P02  
L-XXL ■ 00317P04



XS-M/L □ 00317P01  
L-XXL □ 00317P03



PADDINGS

PADDINGS

### TOP PADDING



THICKNESS	BLACK
10 mm	0032R01XXL
15 mm	0032R01MMLLXL
15+5 mm	0032R01XXS

### CHEEK PADDING



THICKNESS	BLACK	RED
25 mm	0032RF02NR25	0032RF02RS25
30 mm	0032RF02NR30	0032RF02RS30
35 mm	0032RF02NR35	0032RF02RS35
40 mm	0032RF02NR40	0032RF02RS40

RACING  
HELMETS

RACING  
SEATS

RACING  
HARNESSES  
STEERING WHEELS

RACING  
MECHANICS  
TECHNICAL

KARTING  
SUITS  
UNDERWEAR

KARTING  
SHOES / GLOVES  
PROTECTIONS

PERFORMANCE  
SEATS  
HARNESSES  
STEERING WHEELS

e-SPORTS  
SIM RACING  
CHAIRS

TEAMWEAR  
& LIFESTYLE  
CLOTHING  
ACCESSORIES

TEAMWEAR  
& LIFESTYLE  
CAPSULE  
COLLECTIONS

OUTLET



## NEW IS-400

- Professional Digital Intercom control unit, made up of a main case and a remot unit with a 7" screen to manage all settings.
- Selectable noise filters.
- Customize voice equalization.
- Bluetooth telephone module.
- RCA connector for in-car camera.
- AUX connector for telephone and radio.
- Detachable Male/Female Nexus Connectors.
- Stage mode with automatic switch off Bluetooth and Aux channels.
- USB-C connector for rechargeable auxiliary.
- Road trip mode with partials and countdown (GPS opt antenna required cod.00537054).
- Average speed and instantaneous speed display (GPS antenna opt cod.00537054 required).



**IS-400 F**  
00537046BTF



**IS-400 M**  
00537046BTM

**GPS ANTENNA OPT.**  
00537054

**EXTERNAL BUTTON OPT.**  
00537055

## NEW IS-300

- Professional Digital intercom control unit with selectable noise filters.
- Volume independent setting Driver and Co-Driver.
- BlueTooth telephone module.
- Nexus Male/Female connectors with 2m cables.
- RCA connector for in-car camera.
- AUX connector for telephone and radio.
- Stage mode with automatic switch off Bluetooth and Aux channels.
- Power cable for connection to the 12V car battery.
- Rollcage or dashboard attachment.
- USB-C connector for rechargeable auxiliary.



**IS-300 F**  
00537047BTF



**IS-300 M**  
00537047BTM

## NEW IS-200

- New Professional analogic intercom control unit.
- Double potentiometer with independent Driver and Co-Driver volume.
- 6,3mm Jack Female connectors with 2m cables.(Nexus Female Connector for Plus version).
- RCA connector for in-car camera.
- Power cable for connection to the 12V car battery.
- 9V power supply with battery compartment.
- Automatic exclusion of the 9V battery in the presence of a 12V power supply.
- Rollcage or dashboard attachment.



**IS-200 PLUS**  
00537048



**IS-200**  
00537049

## NEW RT- PRO HEADSET

New Sparco headset is design to improve noise reduction and high sound quality thanks to new speaker and microphone.

With Male and Female Nexus Connector.



**RT PRO - F**  
00537050



**RT PRO - M**  
00537053



## GSM

- GSM control unit for clear and stable driver-pits communication.
- Magnetic GSM antenna.
- Antenna fixing bracket for plastic surfaces.
- Nexus male connector.
- Integrated SIM slot.
- On/Off potentiometer with volume control.
- 12V power cable.
- Rollcage or dashboard installation.

Notes: disable the PIN function on the SIM card, the performance of the system depends on the availability of the GSM signal.



00537033

## IS-140

- Professional intercom control unit kit.
- Double potentiometer with independent Driver and Co-Driver volume.
- Nexus Female - Female connectors with 2m cables.
- RCA connector for in-car camera.
- Power cable for connection to the 12V car battery. 9V power supply with battery compartment.
- Automatic exclusion of the 9V battery in the presence of a 12V power supply.
- Rollcage or dashboard attachment with anti-vibration pad.



00537029

## IS-150 BT

- Professional Digital DSP intercom control unit kit with preset noise filters.
- Double potentiometer with independent Driver and Co-Driver volume.
- Bluetooth telephone module.
- With Nexus Female (BT-F) and Male (BT-M) connector.
- RCA connector for in-car camera.
- AUX connector for telephone and radio.
- Power cable for connection to the 12V car battery.
- Rollcage or dashboard attachment with anti-vibration pad.



IS-150 BT-F  
00537030



IS-150 BT-M  
00537038

## IS-110

- Entry level intercom control unit kit with single volume potentiometer.
- 12V car battery connection cable.
- 9V battery compartment.
- 2m driver/navigator cable with 6.3mm female output jack.
- Bottom suitable for rollcage or dashboard attachment.



00537028



# OPEN FACE HELMETS

## INTERCOM KITS ACCESSORIES

### NEW FULL FACE HELMET INTERCOM KIT - NEXUS CONNECT

Nexus Connection.  
Designed to improve communication quality thanks to new speakers and microphone.



00537042

### FULL FACE HELMET INTERCOM KIT - NEXUS CONNECT

Nexus Connection.  
Noise cancelling microphone.  
High-quality speakers.



00537025

### FULL FACE HELMET INTERCOM KIT - NEXUS CONNECT



00537026

### FULL FACE HELMET INTERCOM KIT



00537011

### FULL FACE HELMET INTERCOM KIT



00537013

### ADAPTERS



00537015



00537019

### NEW MICROPHONE KIT

Microphone kit designed for full face helmets in track race use.

Female Nexus connector to be connected to vehicle radio system.

Equipped with a professional Lemo audio connector to be connected to Sparco ear plugs.



00537044

### NEW EAR PLUGS

Ear plugs kit with micro speaker to guarantee a perfect communication quality and noise reduction.



00537045

RACING	HELMETS
RACING	SEATS
RACING	HARNESSES STEERING WHEELS
RACING	MECHANICS TECHNICAL
KARTING	SUITS UNDERWEAR
KARTING	SHOES / GLOVES PROTECTIONS
PERFORMANCE	SEATS HARNESSES STEERING WHEELS
e-SPORTS	SIM RACING CHAIRS
TEAMWEAR & LIFESTYLE	CLOTHING ACCESSORIES
TEAMWEAR & LIFESTYLE	CAPSULE COLLECTIONS
OUTLET	



# ACCESSORIES

## BAG AND HELMET HOLDER

### HELMET AND F.H.R. BAG

**DIMENSION:**  
h 35 x l 35 x p 40 cm - 49 LT.



016441NRSI

### TWO HELMETS CASE



01662A

01662N

### HELMET BAG

**DIMENSION:**  
h 28 x l 42 x p 24 cm - 28 LT.



003111NR

### HELMET HOOK



01666

### HELMETS NET



00313



Steve "Baggy" Biagioni  
Drift Legend

RACING	HELMETS
RACING	SEATS
RACING	HARNESSES STEERING WHEELS
RACING	MECHANICS TECHNICAL
KARTING	SUITS UNDERWEAR
KARTING	SHOES / GLOVES PROTECTIONS
PERFORMANCE	SEATS HARNESSES STEERING WHEELS
e-SPORTS	SIM RACING CHAIRS
TEAMWEAR & LIFESTYLE	CLOTHING ACCESSORIES
TEAMWEAR & LIFESTYLE	CAPSULE COLLECTIONS
OUTLET	



THANKS TO NEW TRADE AGREEMENTS, SPARCO IS ABLE TO PROVIDE THE BEST RANGE OF HEAD RESTRAINT FOR SIZES, STRUCTURE, WEIGHT AND PRICE.

**NEW**  
**HYBRID SPORT**

- Multi-tether system for increased side to side movement.
- Weight: approx 930g.
- DuPont carbon polymer construction.
- Sleek, modern profile with defined wings for seatbelt containment.
- Multiple Load Paths to Dissipate Head Loads.
- FIA approved - SFI 38.1 Certified



00397H..

Low profile.  
No high back to hook on the bars on exit.

SIZES	SMALLEST ADJUSTMENT	LARGEST ADJUSTMENT
XS	81 cm	91 cm
S	91 cm	102 cm
M	102 cm	112 cm
L	112 cm	122 cm
XL	122 cm	132 cm

**CLIPS QUICK RELEASE ANCHORS**



00397HQR

**QUICK RELEASE TETHER 2**



00397HLAC

MOREOVER, THANKS TO THE USUAL CARE FOR ITS PRODUCTS, SPARCO IS THE ONLY FACTORY ABLE TO PROVIDE TO CUSTOMERS A FULLY COMPATIBLE PACKAGE INCLUDING THE ENTIRE SET (HELMET, HARNESS AND SEAT).

**FEATHERLITE**

Material: 100% high strength Carbon.  
Weight: about 310g.  
Sliding Tethers.  
New curvature beam.

DEGREE	SIZES
30	M
20	M - L

00396F..



**CLUB 3**

Material: Thermoplastic.  
Weight: about 640g.  
2 sizes available.  
Sliding Tethers.

DEGREE	SIZES
20	M - L

00394C..



**CLUB**

Material: high resistance PVC.  
Weight: around 950g.  
Ergonomic design shape.  
Sliding Tethers.

DEGREE	SIZES
20	M/L - L/XL

00391C..





# DARWIN SEATS KAGUNU



OUTLET	TEAMWEAR & LIFESTYLE	TEAMWEAR & LIFESTYLE	e-SPORTS	PERFORMANCE	KARTING	KARTING	RACING	RACING	RACING
	CAPSULE COLLECTIONS	CLOTHING ACCESSORIES	SIM RACING CHAIRS	SEATS HARNESSES STEERING WHEELS	SHOES / GLOVES PROTECTIONS	SUITS UNDERWEAR	MECHANICS TECHNICAL	HARNESSES STEERING WHEELS	SEATS



HOMOLOGATION 8862-2009

**SUPERCARBON TECHNOLOGY**

**ADV PRIME / ADV PRIME PAD**

SHELL: CARBON FIBER  
 SIZE: L  
 HRS: YES  
 WEIGHT (GR): SHELL: 8300 / SEAT: 10500

**ADV XT**

SHELL: CARBON FIBER  
 SIZE: L  
 HRS: YES  
 WEIGHT (GR): SHELL: 7500 / SEAT: 10750

**ADV ELITE**

SHELL: CARBON FIBER  
 SIZE: L  
 HRS: YES  
 WEIGHT (GR): SHELL: 7810 / SEAT: 10300

**ADV SCX / ADV SCX-H**

SHELL: CARBON FIBER  
 SIZE: M/L  
 HRS: YES  
 WEIGHT (GR): SHELL **ADV SCX**: 8575 / SEAT: 10750  
 SHELL **ADV SCX-H**: 8575 / SEAT: 10750

**ADV SC**

SHELL: CARBON FIBER  
 SIZE: M  
 HRS: YES  
 WEIGHT (GR): SHELL: 10485 / SEAT: 12900

**ADV COMPETITION / ADV COMPETITION PAD**

SHELL: CARBON FIBER  
 SIZE: M/L  
 HRS: YES  
 WEIGHT (GR): SHELL: 9000 / SEAT: 11200 (11000 PAD)



008033ZNR



008033ZPNR



008002ZNR



008492ZNR



008042ZNR



008052ZNR



008020ZNR



008034ZNR



008034ZPNR

**NEW 8855-2021 STANDARD**

**ADV XT**

SHELL: FIBERGLASS  
 SIZE: L  
 HRS: YES  
 WEIGHT (GR): SHELL: 9700 / SEAT: 12000

**MASTER**

SHELL: FIBERGLASS  
 SIZE: L  
 HRS: YES  
 WEIGHT (GR): SHELL: 11250 / SEAT: 14000

**MATRIX**

SHELL: FIBERGLASS  
 SIZE: L  
 HRS: YES  
 WEIGHT (GR): SHELL: 12000 / SEAT: 14900

**CARBON / CARBON-KEVLAR TECHNOLOGY**

**LEGEND**

SHELL: CARBON-KEVLAR  
 SIZE: S  
 HRS: NO  
 WEIGHT (GR): SHELL: 5300 / SEAT: 6000

**QRT-C**

SHELL: CARBON FIBER  
 SIZE: M  
 HRS: NO  
 WEIGHT (GR): SHELL: 4300 / SEAT: 5500

**GAMMA EVO CARBON**

SHELL: CARBON FIBER  
 SIZE: M/L/XL  
 HRS: NO  
 WEIGHT (GR): SHELL **EVO** / **EVO L**: 4500 / SEAT: 5600  
 SHELL **EVO XL**: 4800 / SEAT: 6100

**CIRCUIT CARBON / CIRCUIT CARBON II**

SHELL: CARBON FIBER  
 SIZE: M/L  
 HRS: YES  
 WEIGHT (GR): SHELL **CIRCUIT**: 6400 / SEAT: 7900  
 SHELL **CIRCUIT II**: 6700 / SEAT: 8200

HOMOLOGATION 8855-2021

HOMOLOGATION 8855-1999



008032FNR



008030FNR



008036SNR



008021ZRS



008021ZNR



008025ZNR



008007ZNR



008013ZNR



008015ZNR



008011ZNR



008019ZNR

RACING SEATS
RACING HARNESSES STEERING WHEELS
RACING MECHANICS TECHNICAL
KARTING SUITS UNDERWEAR
KARTING SHOES / GLOVES PROTECTIONS
PERFORMANCE SEATS HARNESSES STEERING WHEELS
e-SPORTS SIM RACING CHAIRS
TEAMWEAR & LIFESTYLE CLOTHING ACCESSORIES
TEAMWEAR & LIFESTYLE CAPSULE COLLECTIONS
OUTLET



HOMOLOGATION 8855-1999

**CARBON TECHNOLOGY**

**ULTRA CARBON**

SHELL: CARBON FIBER  
 SIZE: S  
 HRS: NO  
 WEIGHT (GR): SHELL / SEAT: 4500

**FIBERGLASS TECHNOLOGY**

**ULTRA**

SHELL: GLASS FIBER  
 SIZE: S  
 HRS: NO  
 WEIGHT (GR): SHEL / SEAT: 6200

**QRT TECHNOLOGY**

**QRT-R / QRT-R SKY**

SHELL: QRT SIZE: M HRS: NO  
 WEIGHT (GR): SHELL: QRT-R: 5900 / SEAT QRT-R: 7600  
 SHELL QRT-R SKY: 5900 / SEAT QRT-R SKY: 8300

**PRO 2000 QRT**

SHELL: QRT SIZE: L HRS: NO  
 WEIGHT (GR): SHELL: 6800 / SEAT: 8000

**PRO ADV QRT**

SHELL: QRT SIZE: M/L HRS: YES  
 WEIGHT (GR): SHELL: 7800 / SEAT: 9300

**CIRCUIT QRT / CIRCUIT II QRT**

SHELL: QRT SIZE: L HRS: YES  
 WEIGHT (GR): SHELL CIRCUIT: 7100 / SEAT CIRCUIT: 8600  
 SHELL CIRCUIT II: 7200 / SEAT CIRCUIT II: 9600



008037ZNR



008037FNR



008012RNR



008012RNRSKY



008016RNR



008017RNR



008019RNR



008011RNR

**QRT TECHNOLOGY**

**EVO QRT RANGE**

SHELL: QRT TAGLIA: M/L/XL HRS: NO  
 WEIGHT (GR): SHELL EVO L QRT: 6500 / SEAT EVO L QRT: 7700  
 SHELL EVO XL QRT: 6700 / SEAT EVO XL QRT: 7900  
 SHELL EVO QRT: 5000 / SEAT EVO QRT: 7300  
 SHELL EVO SKY QRT: 5000 / SEAT EVO SKY QRT: 7300



008007RNR



008007RNRSKY



008013RNR



008015RNR

**EVO QRT X RANGE**

SHELL: QRT SIZE: M/L/XL HRS: NO  
 WEIGHT (GR): SHELL EVO L QRT X: 6500  
 SEAT EVO L QRT X: 7700  
 SHELL EVO XL QRT X: 6700  
 SEAT EVO XL QRT X: 7900  
 SHELL EVO QRT X: 5000  
 SEAT EVO QRT X: 7300



008007XNR



008013XNR



008015XNR

**GRID-Q / GRID-Q SKY**

SHELL: QRT SIZE: M HRS: NO  
 WEIGHT (GR): SHELL GRID-Q: 6500 / SEAT GRID-Q: 7300  
 SHELL GRID-Q SKY: 6500 / SEAT GRID-Q SKY: 7700



008009RNR



008009RNRSKY

**REV QRT**

SHELL: QRT SIZE: S/M HRS: NO  
 WEIGHT (GR): SHELL: 6000 / SEAT: 7100



008014RNR

**TUBULAR FRAME TECHNOLOGY**

**SPRINT RANGE**

SHELL: TUBULAR SIZE: M/L HRS: NO  
 WEIGHT (GR): SHELL SPRINT L: 10400  
 SHELL SPRINT/SPRINT SKY: 7940  
 SEAT SPRINT L: 11000  
 SEAT SPRINT/SPRINT SKY: 9700



008235..



008234L..



008235NRSKY

HOMOLOGATION 8855-1999

\*THE INDICATED WEIGHT IS CALCULATED ON THE AVERAGE VALUE OF THE ANALYZED SAMPLES, IT CAN UNDERGO VARIATIONS.

RACING SEATS

RACING HARNESSES STEERING WHEELS

RACING MECHANICS TECHNICAL

KARTING SUITS UNDERWEAR

KARTING SHOES / GLOVES PROTECTIONS

PERFORMANCE SEATS HARNESSES STEERING WHEELS

e-SPORTS SIM RACING CHAIRS

TEAMWEAR & LIFESTYLE CLOTHING ACCESSORIES

TEAMWEAR & LIFESTYLE CAPSULE COLLECTIONS

OUTLET



**HOMOLOGATION:** FIA 8862-2009  
**MATERIAL:** CARBON FIBER **HRS:** YES  
**WEIGHT (GR):** SHELL: 8300 / SEAT: 10500

MANUFACTURER: SPARCO  
 MODEL: ADV PRIME  
 HOM. NO: AS.095.21  
 FIA STANDARD: 8862-2009



## HIGHLIGHTS



New use of k-point fabric.



Full-length cushion with separate leg rest.

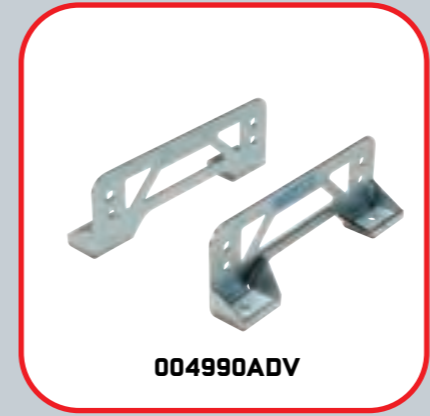

**004990ADV**

The seat is approved in conjunction with the side mounting frames **004990ADV**.



● **008033ZNR**

- Developed in collaboration with M-sport.
- New Lining design.
- Self-extinguishing fabric lining.
- FIA approved energy absorbing padding.
- M12 lateral fastening with 290 mm spacing.

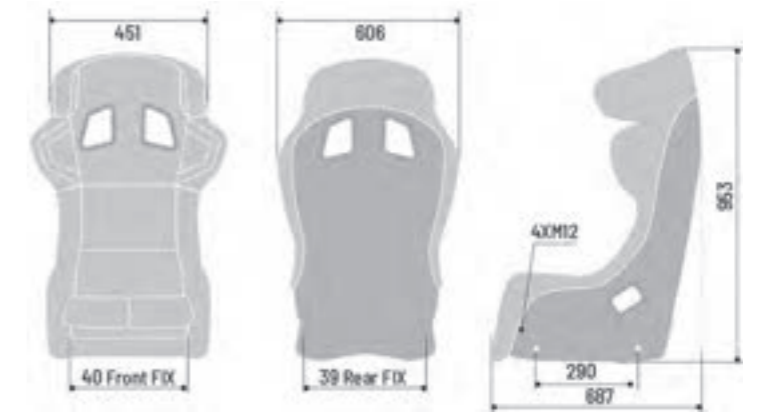

RACING SEATS	RACING HARNESSES STEERING WHEELS	RACING MECHANICS TECHNICAL	KARTING SUITS UNDERWEAR	KARTING SHOES / GLOVES PROTECTIONS	PERFORMANCE SEATS HARNESSES STEERING WHEELS	e-SPORTS SIM RACING CHAIRS	TEAMWEAR & LIFESTYLE CLOTHING ACCESSORIES	TEAMWEAR & LIFESTYLE CAPSULE COLLECTIONS	OUTLET
--------------	----------------------------------	----------------------------	-------------------------	------------------------------------	---	----------------------------	---	--	--------



# ADV PRIME PAD



**HOMOLOGATION:** FIA 8862-2009  
**MATERIAL:** CARBON FIBER **HRS:** YES  
**WEIGHT (GR):** SHELL: 8300 / SEAT: 10500

**MANUFACTURER:** SPARCO  
**MODEL:** ADV PRIME  
**HOM. NO.:** AS.095.21  
**FIA STANDARD:** 8862-2009



## HIGHLIGHTS



New use of k-point fabric.



Full-length cushion with separate leg rest.

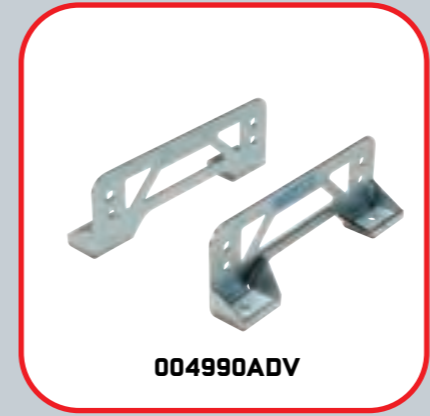

**004990ADV**

The seat is approved in conjunction with the side mounting frames **004990ADV**.



● **008033ZPNR**

- New upholstery design with removable pad in double density foam.



RACING SEATS
RACING HARNESSES STEERING WHEELS
RACING MECHANICS TECHNICAL
KARTING SUITS UNDERWEAR
KARTING SHOES / GLOVES PROTECTIONS
PERFORMANCE SEATS HARNESSES STEERING WHEELS
e-SPORTS SIM RACING CHAIRS
TEAMWEAR & LIFESTYLE CLOTHING ACCESSORIES
TEAMWEAR & LIFESTYLE CAPSULE COLLECTIONS
OUTLET



**HOMOLOGATION:** FIA 8862-2009  
**MATERIAL:** CARBON FIBER **HRS:** YES  
**WEIGHT (GR):** SHELL: 7500 / SEAT: 10750

MANUFACTURER: SPARCO  
 MODEL: ADV XT  
 HOM. NO: AS.064.17  
 FIA STANDARD: 8862-2009

## HIGHLIGHTS



Self-extinguishing fabric lining.



Split leg rest cushion.



0049605

The seat is approved in conjunction with the side mounting frames **0049605**.



008002ZNR

- FIA-approved energy absorbing padding.
- Attached using M12 lateral fastenings with 290 mm spacing.
- Non-slip fabric for shoulders and seat.

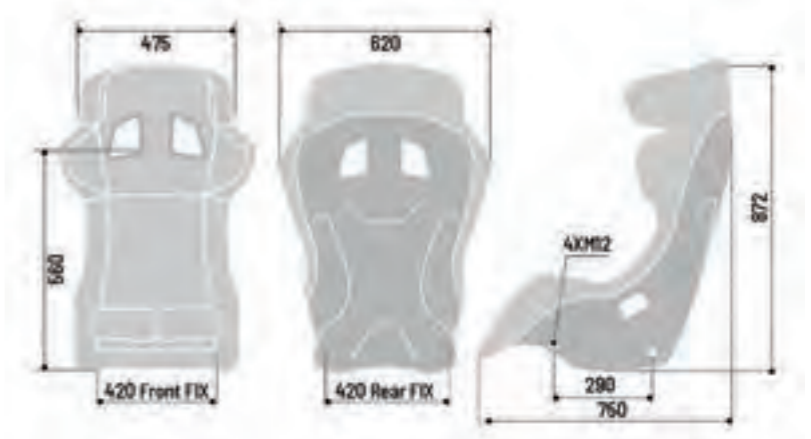

RACING SEATS
HARNESSES STEERING WHEELS
MECHANICS TECHNICAL
SUITS UNDERWEAR
SHOES / GLOVES PROTECTIONS
PERFORMANCE SEATS HARNESSES STEERING WHEELS
e-SPORTS SIM RACING CHAIRS
TEAMWEAR & LIFESTYLE CLOTHING ACCESSORIES
TEAMWEAR & LIFESTYLE CAPSULE COLLECTIONS
OUTLET



**HOMOLOGATION:** FIA 8862-2009  
**MATERIAL:** CARBON FIBER **HRS:** YES  
**WEIGHT (GR):** SHELL: 7810 / SEAT: 10300

MANUFACTURER: SPARCO  
 MODEL: ADV ELITE  
 HOM. NO: AS.037.14  
 FIA STANDARD: 8862-2009



## HIGHLIGHTS



FIA-approved energy absorbing padding.



Non-slip fabric for shoulders and seat.

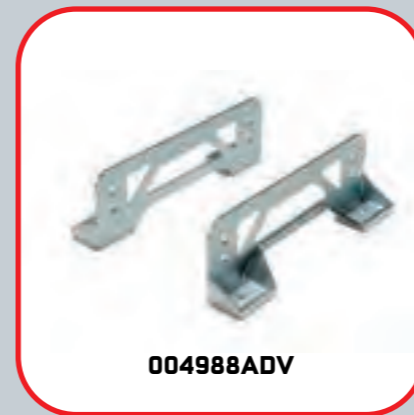

**004988ADV**

The seat is approved in conjunction with the side mounting frames **004988ADV**.

- Self-extinguishing fabric lining.
- Improved habitability and comfort.



● **00849ZNR**

- Attached using M12 lateral fastenings with 290 mm spacing.

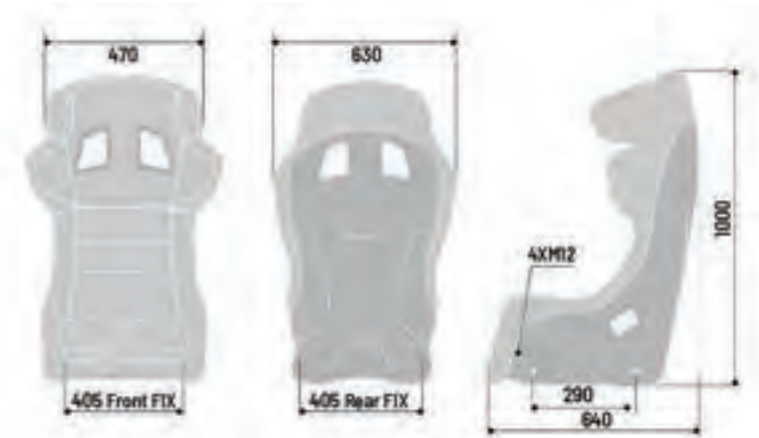

RACING SEATS
RACING HARNESSES STEERING WHEELS
RACING MECHANICS TECHNICAL
KARTING SUITS UNDERWEAR
KARTING SHOES / GLOVES PROTECTIONS
PERFORMANCE SEATS HARNESSES STEERING WHEELS
e-SPORTS SIM RACING CHAIRS
TEAMWEAR & LIFESTYLE CLOTHING ACCESSORIES
TEAMWEAR & LIFESTYLE CAPSULE COLLECTIONS
OUTLET



# ADV SCX / SCX-H

**HOMOLOGATION:** FIA 8862-2009  
**MATERIAL:** CARBON FIBER **HRS:** YES  
**WEIGHT (GR):** SHELL: 8575 / SEAT: 10750



MANUFACTURER: SPARCO  
MODEL: ADV-SCX  
HOM. NO: AS.022.12  
FIA STANDARD: 8862-2009

# ADV SC

**HOMOLOGATION:** FIA 8862-2009  
**MATERIAL:** CARBON FIBER **HRS:** YES  
**WEIGHT (GR):** SHELL: 10485 / SEAT: 12900



MANUFACTURER: SPARCO  
MODEL: ADV-SC 19  
HOM. NO: AS.070.18  
FIA STANDARD: 8862-2009

## HIGHLIGHTS



Non-slip fabric for shoulders and seat.



Split legrest cushion.



**004985ADV (ADV SCX)**  
**004984ADV (ADV SCX-H)**

The seat is approved in conjunction with the side mounting frames ADV SCX and ADV SCX-H.

- Self-extinguishing fabric lining.
- FIA-approved energy absorbing padding.
- Attached using M12 lateral fastenings with 290 mm spacing.



00804ZNR

### ADV SCX-H



MANUFACTURER: SPARCO  
MODEL: ADV-SCX H  
HOM. NO: AS.016.11  
FIA STANDARD: 8862-2009

00805ZNR

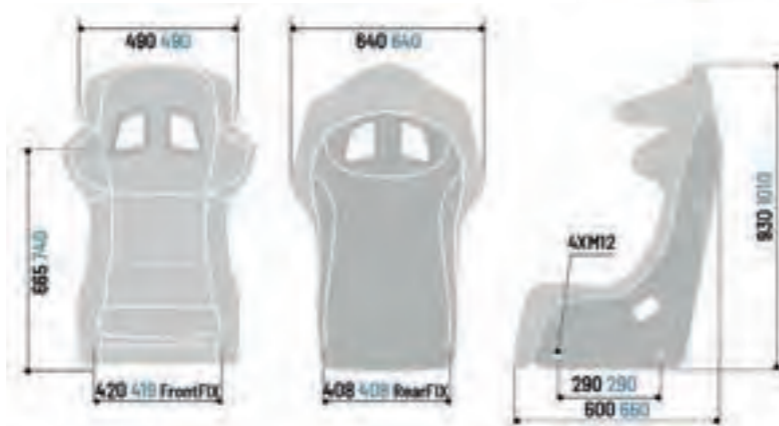

## HIGHLIGHTS



Self-extinguishing fabric lining.



Non-slip fabric for shoulders and seat.



004982ADV

The seat is approved in conjunction with the side mounting frames **004982ADV**.

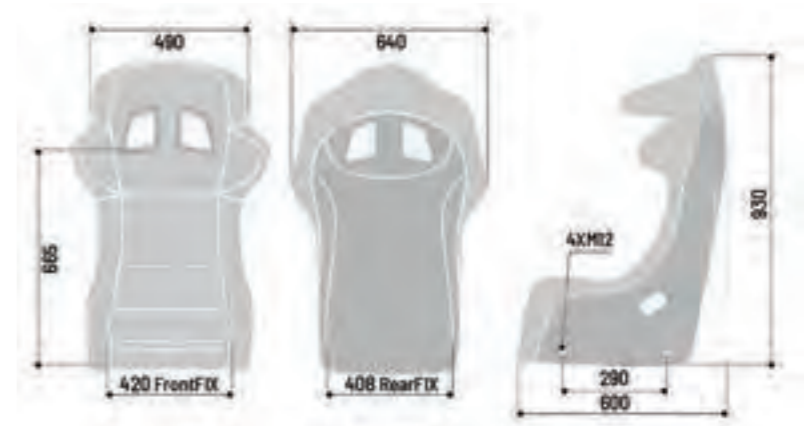

008020ZNR

- FIA-approved energy absorbing padding.
- Attached using M12 lateral fastenings with 290 mm spacing.





# ADV COMPETITION

HOMOLOGATION: FIA 8862-2009 MATERIAL: CARBON FIBER  
HRS: YES WEIGHT (GR): SHELL: 9000 / SEAT: 11200



MANUFACTURER: SPARCO  
MODEL: ADV COMPETITION  
HOM. NO: AS.099.22  
FIA STANDARD: 8862-2009

# ADV COMPETITION

## PAD

HOMOLOGATION: FIA 8862-2009 MATERIAL: CARBON FIBER  
HRS: YES WEIGHT (GR): SHELL: 9000 / SEAT: 11000



MANUFACTURER: SPARCO  
MODEL: ADV COMPETITION  
HOM. NO: AS.099.22  
FIA STANDARD: 8862-2009

## HIGHLIGHTS



New use of k-point fabric.



Full-length cushion with separate leg rest.

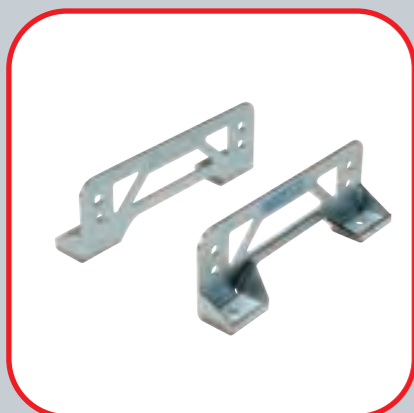

The seat is approved in conjunction with the side mounting frames **004990ADV**.



### 008034ZNR

- Shaped backrest to wrap around the driver.
- Efficient construction technology.



## HIGHLIGHTS



Shaped backrest to better fit the driver.



Backrest with additional reinforcement in the lumbar area.

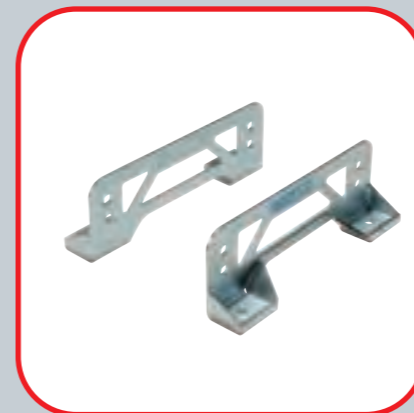

The seat is approved in conjunction with the side mounting frames **004990ADV**.



### 008034ZPNR

- Ergonomics designed for professional drivers.
- Shaped backrest to wrap around the driver.
- Backrest with additional reinforcement in the lumbar area.
- Efficient construction technology.
- New upholstery design with removable pad in double density foam.



RACING SEATS

RACING HARNESSES STEERING WHEELS

RACING MECHANICS TECHNICAL

KARTING SUITS UNDERWEAR

KARTING SHOES / GLOVES PROTECTIONS

PERFORMANCE SEATS HARNESSES STEERING WHEELS

e-SPORTS SIM RACING CHAIRS

TEAMWEAR & LIFESTYLE CLOTHING ACCESSORIES

TEAMWEAR & LIFESTYLE CAPSULE COLLECTIONS

OUTLET



**HOMOLOGATION:** FIA 8855-2021 **MATERIAL:** FIBERGLASS  
**HRS:** YES **WEIGHT (GR):** SHELL: 9700 / SEAT: 12000

MANUFACTURER: SPARCO  
 MODEL: ADV XT  
 HOM. NO: CS.008.21  
 FIA STANDARD: 8855-2021

## HIGHLIGHTS



FIA-approved energy absorbing padding.



Integrated racing net guides.



The seat is approved with two different side mounting frames height (in conjunction with mounting frames **004932H** e **004932L**).



### 008032FNR

- Self-extinguishing fabric lining.
- Split leg rest cushion.
- Suitable for drivers between 1.65 - 1.80 m in height.
- Attached using M12 lateral fastenings with 290 mm spacing.



RACING SEATS
RACING HARNESSES STEERING WHEELS
RACING MECHANICS TECHNICAL
KARTING SUITS UNDERWEAR
KARTING SHOES / GLOVES PROTECTIONS
PERFORMANCE SEATS HARNESSES STEERING WHEELS
e-SPORTS SIM RACING CHAIRS
TEAMWEAR & LIFESTYLE CLOTHING ACCESSORIES
TEAMWEAR & LIFESTYLE CAPSULE COLLECTIONS
OUTLET



**HOMOLOGATION:** FIA 8855-2021 **MATERIAL:** FIBERGLASS  
**HRS:** YES **WEIGHT (GR):** SHELL: 11250 / SEAT: 14000

MANUFACTURER: SPARCO  
MODEL: MASTER  
HOM. NO: CS.004.21  
FIA STANDARD: 8855-2021



## HIGHLIGHTS



Insertion of internal memory foam pads.



Integrated racing net guides.



The seat is approved in conjunction with mounting frames **004919**.

Specific brackets approved for: **Renault Clio RALLY3, RALLY4, RALLY5, Ford Fiesta RALLY3.**



### 008030FNR

- New seat compliant with the more stringent 8855-2021 approval.
- Suitable for drivers between 1.75 - 1.95 m in height.
- Shock absorbing foam on the head.
- Non-slip fabric for shoulders and seat.



RACING SEATS

RACING HARNESSES STEERING WHEELS

RACING MECHANICS TECHNICAL

KARTING SUITS UNDERWEAR

KARTING SHOES / GLOVES PROTECTIONS

PERFORMANCE SEATS HARNESSES STEERING WHEELS

e-SPORTS SIM RACING CHAIRS

TEAMWEAR & LIFESTYLE CLOTHING ACCESSORIES

TEAMWEAR & LIFESTYLE CAPSULE COLLECTIONS

OUTLET



**HOMOLOGATION:** FIA 8855-2021 **MATERIAL:** FIBERGLASS  
**HRS:** YES **WEIGHT (GR):** SHELL: 12000 / SEAT: 14900

MANUFACTURER: SPARCO  
MODEL: MATRIX  
HOM. NO: CS.018.23  
FIA STANDARD: 8855-2021

Official 2024 Peugeot Rally 4 seat



## HIGHLIGHTS



Developed according to the new technical regulations 8855-2021.



Special reinforcing foil with honeycomb matrix.



The seat is approved in conjunction with the side mounting frames **004926**.

Specific brackets approved for: **Peugeot 208 RALLY4**.



● **008036SNR**

- Designed for greater ergonomics using sae manikin.
- New efficient construction technology.

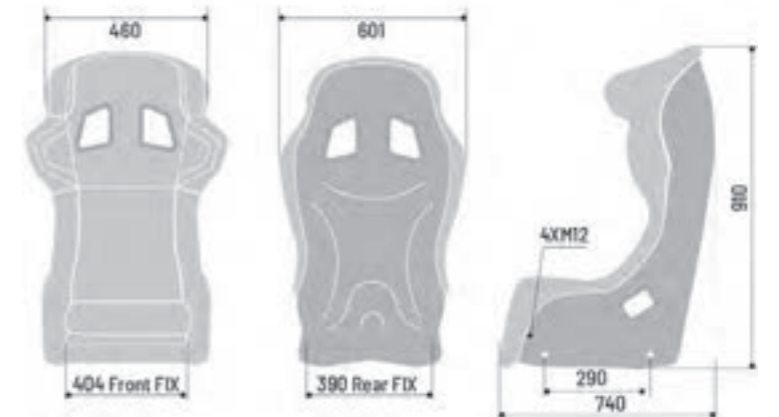



# LEGEND

**HOMOLOGATION:** FIA 8855-1999  
**MATERIAL:** CARBON-KEVLAR PRE-PREG  
**HRS: NO** **WEIGHT (GR):** SHELL: 5300 / SEAT: 6000



MANUFACTURER: SPARCO  
MODEL: LEGEND  
HOM. NO: CS.459.20  
FIA STANDARD: 8855-1999

# QRT-C

**HOMOLOGATION:** FIA 8855-1999  
**MATERIAL:** CARBON FIBER **HRS: NO**  
**WEIGHT (GR):** SHELL: 4300 / SEAT: 5500



MANUFACTURER: SPARCO  
MODEL: QRT-C 20  
HOM. NO: CS.437.19  
FIA STANDARD: 8855-1999

## HIGHLIGHTS



VEP fabric with original checkered lining.



Pre-preg carbon-kevlar frame.



Lower fasteners 317x345 (M8) (does not mount on guide **00943..**).



008021ZRS



008021ZNR

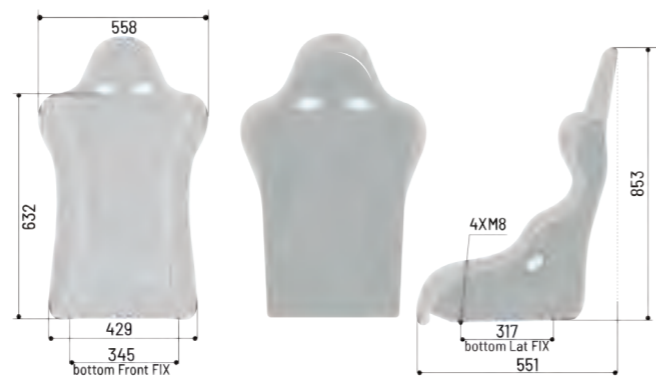

## HIGHLIGHTS



High structural strength.



Non-slip fabric for shoulders and seat.



Attached using M8 lateral fastenings with 290 mm spacing.



008025ZNR

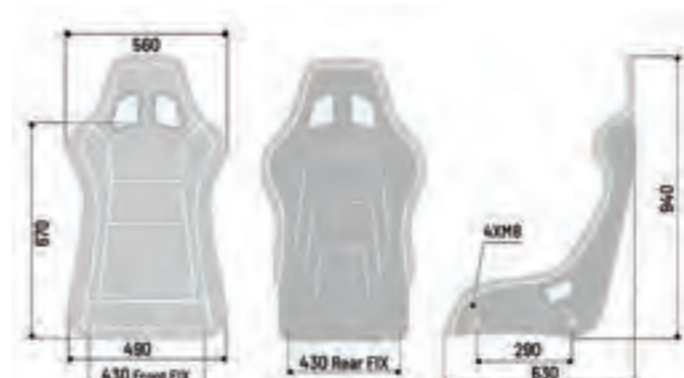

RACING SEATS

RACING HARNESSES STEERING WHEELS

RACING MECHANICS TECHNICAL

KARTING SUITS UNDERWEAR

KARTING SHOES / GLOVES PROTECTIONS

PERFORMANCE SEATS HARNESSES STEERING WHEELS

e-SPORTS SIM RACING CHAIRS

TEAMWEAR & LIFESTYLE CLOTHING ACCESSORIES

TEAMWEAR & LIFESTYLE CAPSULE COLLECTIONS

OUTLET



# EVO CARBON

**HOMOLOGATION:** FIA 8855-1999 **MATERIAL:** CARBON FIBER  
**HRS:** NO **WEIGHT (GR):** SHELL 4500 / SEAT 5600

## HIGHLIGHTS



Non-slip fabric for shoulders and seat.



Super light shell in carbon fiber.



Attached using M8 lateral fastenings with 290 mm spacing.



MANUFACTURER: SPARCO  
MODEL: EVO CARBON  
HOM. NO: CS.485.22  
FIA STANDARD: 8855-1999



● 008007ZNR



# EVO CARBON

L/XL

**HOMOLOGATION:** FIA 8855-1999 **MATERIAL:** CARBON FIBER **HRS:** NO  
**WEIGHT (GR):** EVO L SHELL: 4500 / SEATS: 5600 - EVO XL SHELL: 4800 / SEATS: 6100

## HIGHLIGHTS



Non-slip fabric for shoulders and seat.



Super light shell in carbon fiber.



Attached using M8 lateral fastenings with 290 mm spacing.

### EVO L CARBON



MANUFACTURER: SPARCO  
MODEL: EVO L CARBON  
HOM. NO: CS.486.22  
FIA STANDARD: 8855-1999



● 008013ZNR

### EVO XL CARBON



MANUFACTURER: SPARCO  
MODEL: EVO XL CARBON  
HOM. NO: CS.487.22  
FIA STANDARD: 8855-1999



● 008015ZNR





# CIRCUIT CARBON

**HOMOLOGATION:** FIA 8855-1999 **MATERIAL:** CARBON FIBER  
**SIZE:** M **HRS:** YES **WEIGHT (GR):** SHELL: 6400 / SEAT: 7900

## HIGHLIGHTS



Non-slip fabric for shoulder and seat restraint.



Super light shell in carbon fiber.



Divisible leg rest and seat cushion.



# CIRCUIT II CARBON

**HOMOLOGATION:** FIA 8855-1999 **MATERIAL:** CARBON FIBER  
**SIZE:** L **HRS:** YES **WEIGHT (GR):** SHELL: 6700 / SEAT: 8200

## HIGHLIGHTS



Non-slip fabric for shoulder and seat restraint.



Super light shell in carbon fiber.



Divisible leg rest and seat cushion.





**HOMOLOGATION:** FIA 8855-1999 **MATERIAL:** CARBON FIBER  
**SIZE:** S **HRS:** NO **WEIGHT (GR):** SHELL / SEAT: 4500

MANUFACTURER: SPARCO  
 MODEL: ULTRA CARBON  
 HOM. NO: CS.500.22  
 FIA STANDARD: 8855-1999



## HIGHLIGHTS



Ultralight seat.



Laminated with double shell in Carbon Fiber.



Ergonomics designed for use without padding.



■ Suitable for narrow cockpits.



**008037ZNR**

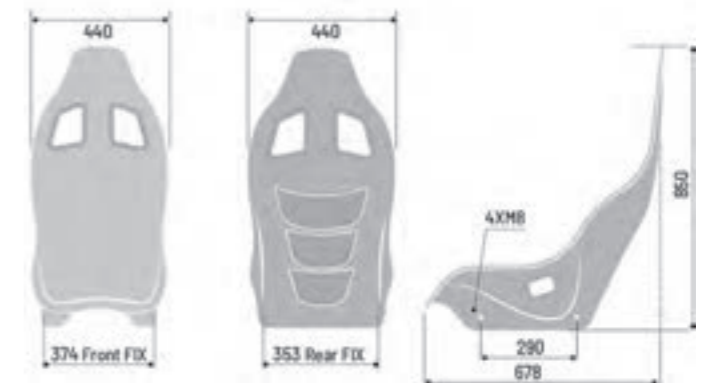





MANUFACTURER: SPARCO  
 MODEL: ULTRA  
 HOM. NO: CS.499.22  
 FIA STANDARD: 8855-1999

HOMOLOGATION: FIA 8855-1999 MATERIAL: FIBERGLASS  
 SIZE: S HRS: NO WEIGHT (GR): SHELL / SEAT: 6200

## HIGHLIGHTS



Ultralight seat.



Laminated with double shell in Glass Fiber.



Ergonomics designed for use without padding.



- Suitable for narrow cockpits.



SPACERS KIT OF 4. 20MM

04503

- Nylon spacer bushings



### NEW ULTRA PADDING FULL KIT ALCANTARA®



Padding kit consisting of:

- Headrest
- Scapular
- Lumbar
- Cushion

Alcantara-covered pads.  
 Possibility of repositioning the pads on the shell by means of Velcro.  
 Foam padding made of anti-vibration material.

010411PAD1

### NEW ULTRA HEAD+BOTTOM PADDING ALCANTARA®



Padding kit for cushion and headrest covered in Alcantara.  
 Possibility of repositioning the pads on the shell via Velcro.  
 Foam padding made of anti-vibration material.

010411PAD3

### NEW ULTRA PADDING FULL KIT OPT



Padding kit consisting of:

- Headrest
- Scapular
- Lumbar
- Cushion

Waterproof coated pads.  
 Possibility of repositioning the pads on the shell by means of Velcro.  
 Foam padding made of anti-vibration material.

010411PAD2

### NEW ULTRA HEAD+BOTTOM PADDING OPT



Padding kit for cushion and headrest covered in waterproof material.  
 Possibility of repositioning the pads on the shell via Velcro.  
 Foam padding made of anti-vibration material.

010411PAD4

RACING SEATS

RACING HARNESSES STEERING WHEELS

RACING MECHANICS TECHNICAL

KARTING SUITS UNDERWEAR

KARTING SHOES / GLOVES PROTECTIONS

PERFORMANCE SEATS HARNESSES STEERING WHEELS

e-SPORTS SIM RACING CHAIRS

TEAMWEAR & LIFESTYLE CLOTHING ACCESSORIES

TEAMWEAR & LIFESTYLE CAPSULE COLLECTIONS

OUTLET



# QRT-R

**HOMOLOGATION:** FIA 8855-1999 **MATERIAL:** QRT  
**HRS: NO WEIGHT (GR):** SHELL: 5900 / SEAT: 7600



MANUFACTURER: SPARCO  
MODEL: QRT-R  
HOM. NO: CS.397.18  
FIA STANDARD: 8855-1999

# PRO 2000 QRT

**HOMOLOGATION:** FIA 8855-1999 **MATERIAL:** QRT  
**HRS: NO WEIGHT (GR):** SHELL: 6800 / SEAT: 8000



MANUFACTURER: SPARCO  
MODEL: PRO 2000 QRT  
HOM. NO: CS.424.19  
FIA STANDARD: 8855-1999

## HIGHLIGHTS



Non-slip fabric for shoulders and seat.



Integrated lumbar support.



Attached using M8 lateral fastenings with 290 mm spacing.



● 008012RNR

### QRT-R SKY



MANUFACTURER: SPARCO  
MODEL: QRT-R  
HOM. NO: CS.397.18  
FIA STANDARD: 8855-1999

- Attached using M8 lateral fastenings with 290 mm spacing.



● 008012RNRSKY



## HIGHLIGHTS



Non-slip fabric for shoulder and seat restraint.



Lateral kidney supports.



Divisible leg rest and seat cushion.



● 008016RNR

- Lower attached directly on M8 271x345 base.
- Attached using M8 lateral fastenings with 290 mm spacing.



RACING SEATS

RACING HARNESSES STEERING WHEELS

RACING MECHANICS TECHNICAL

KARTING SUITS UNDERWEAR

KARTING SHOES / GLOVES PROTECTIONS

PERFORMANCE SEATS HARNESSES STEERING WHEELS

e-SPORTS SIM RACING CHAIRS

TEAMWEAR & LIFESTYLE CLOTHING ACCESSORIES

TEAMWEAR & LIFESTYLE CAPSULE COLLECTIONS

OUTLET



# PRO ADV QRT

**HOMOLOGATION:** FIA 8855-1999 **MATERIAL:** QRT  
**HRS:** YES **WEIGHT (GR):** SHELL: 7800 / SEAT: 9300



MANUFACTURER: SPARCO  
MODEL: PRO ADV QRT  
HOM. NO: CS.434.19  
FIA STANDARD: 8855-1999

# CIRCUIT QRT

**HOMOLOGATION:** FIA 8855-1999 **MATERIAL:** QRT **HRS:** YES  
**WEIGHT (GR):** SHELL **CIRCUIT QRT:** 7100 / SEAT **CIRCUIT QRT:** 8600  
SHELL **CIRCUIT II QRT:** 8600 / SEAT **CIRCUIT II QRT:** 9600



MANUFACTURER: SPARCO  
MODEL: CIRCUIT QRT 20  
HOM. NO: CS.431.19  
FIA STANDARD: 8855-1999

## HIGHLIGHTS



Non-slip fabric for shoulder and seat restraint.



Divisible leg rest and seat cushion.



Attached using M8 lateral fastenings.



● 008017RNR

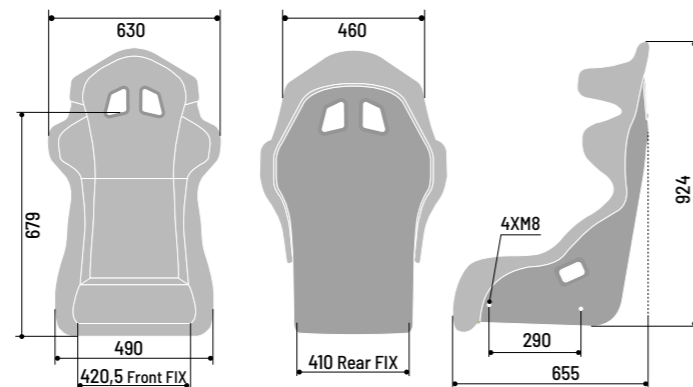

## HIGHLIGHTS



Head Restraint System integrated.



Non-slip fabric for shoulder and seat restraint.



Divisible leg rest and seat cushion.



● 008019RNR

## CIRCUIT II QRT



MANUFACTURER: SPARCO  
MODEL: CIRCUIT II QRT  
HOM. NO: CS.408.18  
FIA STANDARD: 8855-1999



■ Attached using M8 lateral fastenings with 290 mm spacing.

● 008011RNR





# EVO QRT

**HOMOLOGATION:** FIA 8855-1999 **MATERIAL:** QRT  
**HRS: NO** **WEIGHT (GR):** SHELL: 5000 / SEAT: 7300



MANUFACTURER: SPARCO  
MODEL: EVO QRT  
HOM. NO: CS.373.17  
FIA STANDARD: 8855-1999

# EVO QRT L/XL

**HOMOLOGATION:** FIA 8855-1999 **MATERIAL:** QRT **HRS: NO**  
**WEIGHT (GR):** SHELL **EVO L QRT:** 6500 / SEAT **EVO L QRT:** 7700  
SHELL **EVO XL QRT:** 6700 / SEAT **EVO XL QRT:** 7900



MANUFACTURER: SPARCO  
MODEL: EVO L QRT  
HOM. NO: CS.432.19  
FIA STANDARD: 8855-1999

## HIGHLIGHTS



New backrest with integrated lumbar cushions.



Divisible leg rest and seat cushion.



Attached using MB lateral fastenings with 290 mm spacing.



● 008007RNR

## EVO SKY QRT



■ Sky upholstery.

● 008007RNRSKY

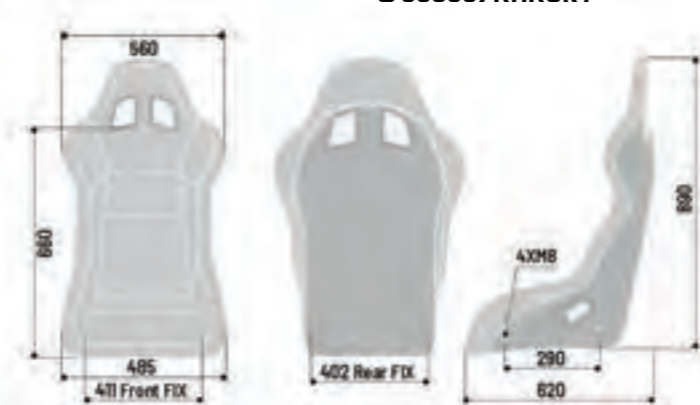

## HIGHLIGHTS



New backrest with integrated lumbar cushions.



Divisible leg rest and seat cushion.



Attached using MB lateral fastenings with 290 mm spacing.

## EVO L QRT



● 008013RNR

## EVO XL QRT



MANUFACTURER: SPARCO  
MODEL: EVO XL QRT  
HOM. NO: CS.433.19  
FIA STANDARD: 8855-1999



● 008015RNR



RACING SEATS

RACING HARNESSES STEERING WHEELS

RACING MECHANICS TECHNICAL

KARTING SUITS UNDERWEAR

KARTING SHOES / GLOVES PROTECTIONS

PERFORMANCE SEATS HARNESSES STEERING WHEELS

e-SPORTS SIM RACING CHAIRS

TEAMWEAR & LIFESTYLE CLOTHING ACCESSORIES

TEAMWEAR & LIFESTYLE CAPSULE COLLECTIONS

OUTLET



# EVO QRT X

WATER-REPELLENT

HOMOLOGATION: FIA 8855-1999 MATERIAL: QRT HRS: NO  
WEIGHT (GR): SHELL EVO QRT X: 5000 / SEAT EVO QRT X: 7300



MANUFACTURER: SPARCO  
MODEL: EVO QRT  
HOM. NO: CS.373.17  
FIA STANDARD: 8855-1999

# EVO QRT X L/XL

WATER-REPELLENT

HOMOLOGATION: FIA 8855-1999 MATERIAL: QRT HRS: NO  
WEIGHT (GR): SHELL EVO L QRT X: 6500 / SEAT EVO XL QRT X: 7700  
SHELL EVO XL QRT X: 6700 / SEAT EVO XL QRT X: 7900



MANUFACTURER: SPARCO  
MODEL: EVO L QRT  
HOM. NO: CS.432.19  
FIA STANDARD: 8855-1999

## HIGHLIGHTS



Waterproof fabric specific for off-road use.



Divisible leg rest and seat cushion.



Attached using MB lateral fastenings with 290 mm spacing.



008007XNR

### OFFROAD CUSHION

P. 175



01033NR

01034XNR



## HIGHLIGHTS



Waterproof fabric specific for off-road use.



Divisible leg rest and seat cushion.



Attached using MB lateral fastenings with 290 mm spacing.

## EVO L QRT X



008013XNR

## EVO XL QRT X



MANUFACTURER: SPARCO  
MODEL: EVO XL QRT  
HOM. NO: CS.433.19  
FIA STANDARD: 8855-1999



008015XNR





# GRID-Q QRT

HOMOLOGATION: FIA 8855-1999 MATERIAL: QRT  
HRS: NO WEIGHT (GR): SHELL 6500 / SEAT 7300



MANUFACTURER: SPARCO  
MODEL: GRID Q  
HOM. NO: CS.407.18  
FIA STANDARD: 8855-1999

# REV QRT

HOMOLOGATION: FIA 8855-1999 MATERIAL: QRT  
HRS: NO WEIGHT (GR): SHELL 6000 / SEAT 7100



MANUFACTURER: SPARCO  
MODEL: REV QRT  
HOM. NO: CS.423.19  
FIA STANDARD: 8855-1999

## HIGHLIGHTS



Non-slip fabric for shoulder and seat restraint.



Customizable padded pads.



Divisible leg rest and seat cushion.



008009RNR

### GRID-Q SKY QRT



008009RNRSKY

- Attached using M8 Lateral fastenings with 290 mm spacing.

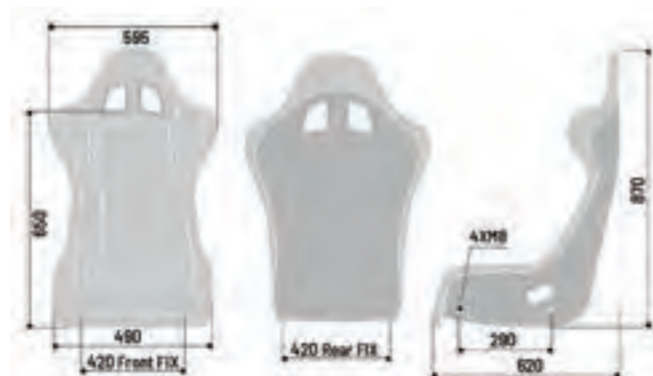

## HIGHLIGHTS



Non-slip fabric for shoulder and seat restraint.



New backrest with integrated lumbar cushions.



Attached using M8 lateral fastenings with 290 mm spacing.



008014RNR



RACING SEATS	RACING HARNESSES STEERING WHEELS	RACING MECHANICS TECHNICAL	KARTING SUITS UNDERWEAR	KARTING SHOES / GLOVES PROTECTIONS	PERFORMANCE SEATS HARNESSES STEERING WHEELS	e-SPORTS SIM RACING CHAIRS	TEAMWEAR & LIFESTYLE CLOTHING ACCESSORIES	TEAMWEAR & LIFESTYLE CAPSULE COLLECTIONS	OUTLET
--------------	----------------------------------	----------------------------	-------------------------	------------------------------------	---	----------------------------	---	--	--------



# SPRINT/SPRINT L

**HOMOLOGATION:** FIA 8855-1999 **MATERIAL:** TUBULAR FRAME  
**HRS: NO WEIGHT (GR): SHELL SPRINT:** 7940 / **SEAT SPRINT:** 9700  
**SHELL SPRINT L:** 10400 / **SEAT SPRINT L:** 11000



**MANUFACTURER:** SPARCO  
**MODEL:** SPRINT  
**HOM. NO.:** CS.332.15  
**FIA STANDARD:** 8855-1999

# SPRINT SKY

**HOMOLOGATION:** FIA 8855-1999 **MATERIAL:** TUBULAR FRAME  
**HRS: NO WEIGHT (GR): SHELL SPRINT SKY:** 7940  
**SEAT SPRINT SKY:** 9700



**MANUFACTURER:** SPARCO  
**MODEL:** SPRINT  
**HOM. NO.:** CS.332.15  
**FIA STANDARD:** 8855-1999

## HIGHLIGHTS

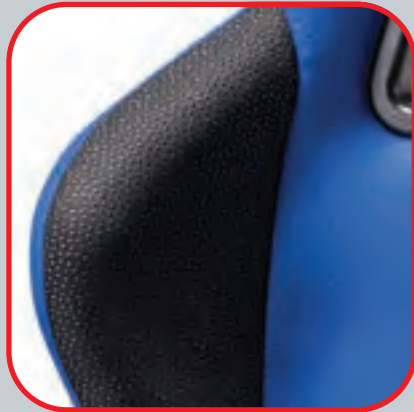

Non-slip fabric for shoulder and seat restraint.



Tubular frame with elastic backrest and seat structure.



Lower attached directly on M8 271x345 base. Attached using M8 lateral fastenings with 290 mm spacing.

- 008235RS
- 008235AZ
- 008235NR

### SPRINT L



**MANUFACTURER:** SPARCO  
**MODEL:** SPRINT L  
**HOM. NO.:** CS.314.14  
**FIA STANDARD:** 8855-1999

- 008234LRS
- 008234LAZ
- 008234LNR



## HIGHLIGHTS



Non-slip fabric for shoulder and seat restraint.



Sky upholstery.



Lower attached directly on M8 271x345 base. Attached using M8 lateral fastenings with 290 mm spacing.

- 008235NRSKY

- Elastic backrest and seat structure.
- Lower attached directly on M8 271x345 base.

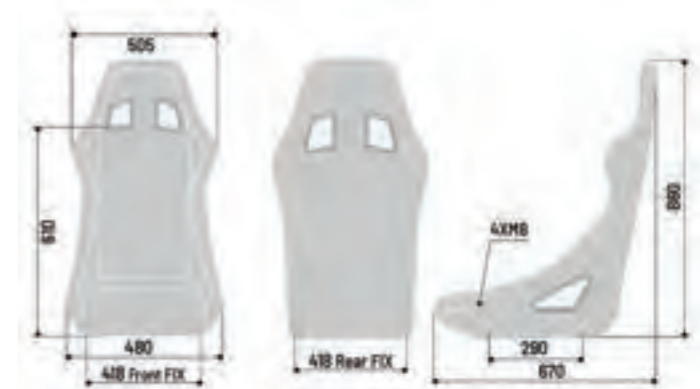

RACING SEATS

RACING HARNESSES STEERING WHEELS

RACING MECHANICS TECHNICAL

KARTING SUITS UNDERWEAR

KARTING SHOES / GLOVES PROTECTIONS

PERFORMANCE SEATS HARNESSES STEERING WHEELS

e-SPORTS SIM RACING CHAIRS

TEAMWEAR & LIFESTYLE CLOTHING ACCESSORIES

TEAMWEAR & LIFESTYLE CAPSULE COLLECTIONS

OUTLET



### FIA-APPROVED MOUNTING FRAMES FOR SEATS WITH SIDE MOUNTING



**004903**  
Longitudinal distance between holes 290 mm. Max length 415 mm. Simple mounting in the car with more than 25 positions. 6 mm anodized aluminium.



**00492LAT**  
Dismountable mounting frame made of Steel. Maximum height and length adjustability (22 eyelets on the base element). New L shape of the lateral element to allow a double lockage with the base element.



**004915**  
290 mm spacing. High resistance steel, 3 mm thick. 500 mm length.



**004902**  
Longitudinal distance between holes 290 mm. Max length 400 mm. Simple mounting in the car with more than 25 positions. 3 mm black powder coated.



**004901NR**  
(L max 360 mm) Longitudinal wheelbase 290 mm. 3 mm thick steel.

### SUBFRAMES FOR BOTTOM MOUNTING

FOR THE COMPLETE APPLICATION LIST SEE THE PRICE LIST.



### DRIVER DRINK



**01045NR**

Drink bag. Insulates from outside heat and keeps drinks at a constant temperature. Holds 1.5 litres, inner bottle and spout also available as spare parts. Four braces for attachment to the seat.

### OFF ROAD CUSHION LOW - FIA COMPLIANT



Memory foam cushion.  
**01033NR**

Water repellent version.  
**01033XNR**

High density foam water repellent version.  
**01035XNR**

### OFF ROAD CUSHION HIGH - NOT FIA COMPLIANT



Water repellent memory foam cushion high.  
**01034XNR**

High density foam water repellent version.  
**01036XNR**

### OPTIONAL PADDING



**04108009PAD**  
Pair of side cushions suitable for FIA 8855-1999 seats.



**01011**  
Leg support cushion.



● **01022NR**  
● **01022AZ**  
● **01022RS**  
Pair of lumbar side backrests.



**01023**  
Universal lumbar backrest.

### CUSHION FULL KIT (BACK + BOTTOM)



CODE	SEAT
01048KIT8007NR	EVO QRT
01048KIT8007SKY	EVO QRT SKY
01048KIT8013NR	EVO L QRT
01048KIT8015NR	EVO XL QRT
01048KIT8014NR	REV QRT
01048KIT8012NR	QRT R
01048KIT8012SKY	QRT-R SKY
01048KIT8025NR	QRT-C



CODE	SEAT
01048KIT8019NR	CIRCUIT
01048KIT8011NR	CIRCUIT II
01048KIT8017NR	PRO ADV QRT
01048KIT8016NR	PRO 2000 QRT
01048KIT8018NR	PILOT QRT
01048KIT8009NR	GRID Q
01048KIT8009SKY	GRID Q SKY



# DAPINNA HARNESSES KAWAIIYU



TEAMWEAR & LIFESTYLE	TEAMWEAR & LIFESTYLE	e-SPORTS	PERFORMANCE	KARTING	KARTING	RACING	RACING
CAPSULE COLLECTIONS	CLOTHING ACCESSORIES	SIM RACING CHAIRS	SEATS HARNESSES STEERING WHEELS	SHOES / GLOVES PROTECTIONS	SUITS UNDERWEAR	MECHANICS TECHNICAL	HARNESSES STEERING WHEELS
OUTLET							



# HARNESSES INDEX

MADE IN ITALY

HOMOLOGATION 8853-2016

**FORMULA**

**FORMULA H-10** 

TYPE: FORMULA  
FIXING: DOGBONE / BOLT ON  
ANCHORAGE POINT: 6 POINTS



**FORMULA H-9 INDY**  **NEW**

TYPE: FORMULA  
FIXING: DOGBONE ON SHOULDER / BOLT ON  
ANCHORAGE POINT: 8 POINTS



**FORMULA H-9** 

TYPE: FORMULA  
FIXING: DOGBONE ON SHOULDER / BOLT ON  
ANCHORAGE POINT: 6 POINTS



**FORMULA H-8**

TYPE: FORMULA  
FIXING: DOGBONE ON SHOULDER / BOLT ON  
ANCHORAGE POINT: 6 POINTS



**FORMULA H-7**

TYPE: FORMULA  
FIXING: ROLLAGE / BOLT ON  
ANCHORAGE POINT: 6 POINTS



**PRO RALLY / GT / SALOON**

**PRO H-9**

TYPE: RALLY / GT / SALOON  
FIXING: ROLLAGE / CARABINER / DOGBONE (ON DEMAND)  
ANCHORAGE POINT: 6 POINTS



**PRO H-8 ENDURANCE**

TYPE: RALLY / GT / SALOON  
FIXING: BOLT ON / ROLLAGE / DOGBONE (ON DEMAND)  
ANCHORAGE POINT: 6 POINTS



HOMOLOGATION 8853-2016

**COMPETITION RALLY / GT / SALOON**

**COMPETITION H-3+2**

TYPE: RALLY / GT / SALOON  
FIXING: ROLLAGE / SNAP ON  
ANCHORAGE POINT: 6 POINTS



**COMPETITION H-3 STEEL** **NEW**

TYPE: RALLY / GT / SALOON  
FIXING: ROLLAGE / SNAP ON  
ANCHORAGE POINT: 6 POINTS



**COMPETITION H-2 PU** **NEW**

TYPE: RALLY / GT / SALOON  
FIXING: ROLLAGE / SNAP ON  
ANCHORAGE POINT: 6 POINTS



**COMPETITION H-2 PD**

TYPE: RALLY / GT / SALOON  
FIXING: ROLLAGE / SNAP ON  
ANCHORAGE POINT: 6 POINTS

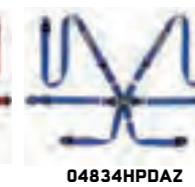

8854-1998

**SPORT RALLY / SALOON / HISTORICAL**

**SPORT H-4**

TYPE: RALLY / SALOON  
FIXING: ROLLAGE / SNAP ON  
ANCHORAGE POINT: 4 POINTS



SFI

**SPORT OFFROAD / OFFSHORE**

**SPORT H-5 SFI / SFI CAMO**

TYPE: OFFROAD / OFFSHORE  
FIXING: ROLLAGE / SNAP ON  
ANCHORAGE POINT: 5 POINTS

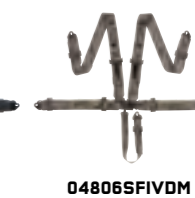





MANUFACTURER: SPARCO  
MODEL: 04822H  
HOM. NO: SH.060.19-T-6  
FIA STANDARD: 8853-2016

HOMOLOGATION: FIA 8853-2016

## HIGHLIGHTS

- 6-Point or 8-Point belt.
- 2" specific FHR shoulder straps.
- Full release titanium buckle.
- Aluminum adjusters.
- Dogbone fixing (screw fixing on request).
- **Oracle Red Bull Racing F1 Team** and **McLaren F1 Racing Team** official equipment.

## THE LIGHTEST IN FORMULA 1



04822HNR



RACING

HARNESSES

RACING

MECHANICS  
TECHNICAL

KARTING

SUITS  
UNDERWEAR

KARTING

SHOES / GLOVES  
PROTECTIONS

PERFORMANCE

SEATS  
HARNESSES  
STEERING WHEELS

e-SPORTS

SIM RACING  
CHAIRS

TEAMWEAR  
& LIFESTYLE

CLOTHING  
ACCESSORIES

TEAMWEAR  
& LIFESTYLE

CAPSULE  
COLLECTIONS

OUTLET



# FORMULA H-9



HOMOLOGATION: FIA 8853-2016



MANUFACTURER: SPARCO  
MODEL: 04833H  
HOM. NO: SH.073.19-T-6  
FIA STANDARD: 8853-2016

## HIGHLIGHTS

- 6 point seat belt for single-seater.
- 2" specific FHR straps.
- Pecific f1 straps and aluminum adjusters.
- Luminum buckle with fixed point on abdominal.
- Fixing with adjustable double tongue.
- f1 straps and aluminum adjusters.



04833HNR

# FORMULA H-8



MANUFACTURER: SPARCO  
MODEL: 04823HNR  
HOM. NO: SH.054.18-T-6  
FIA STANDARD: 8853-2016

## HIGHLIGHTS

- 6 point seat belt for single-seater.
- 2" specific FHR straps.
- Aluminum buckle.
- Aluminum adjusters only on shoulder straps.
- Adjustable abdominal and thigh straps.
- Triangle screw fixings, 15 mm diameter hole, roll-cage or dog bone mounting possible by eliminating triangles.



04823HNR

# FORMULA H-9 INDY **NEW**

HOMOLOGATION: FIA 8853-2016



MANUFACTURER: SPARCO  
MODEL: 04843H  
HOM. NO: SH.XXX.23-T-8  
FIA STANDARD: 8853-2016

## HIGHLIGHTS

- INDY CAR specific 8-point harness.
- Shoulder straps derived from Formula 1.
- 2" FHR Shoulder straps.
- Aluminum buckle.
- Adjusters derived from F1.
- Straps attachment to DOGBONE.
- Abdominal and thigh strap fixings.



04843NR

# FORMULA H-7



MANUFACTURER: SPARCO  
MODEL: 04819H  
HOM. NO: SH.017.17-T-6  
FIA STANDARD: 8853-2016

## HIGHLIGHTS

- 6 point seat belt for single-seater.
- 2" specific FHR straps.
- Aluminum buckle.
- Steel adjusters on shoulder and abdominal straps.
- Triangle screw fixings, 15 mm diameter hole, roll-cage or dog bone mounting possible by eliminating triangles.



■ 04819H2NR  
■ 04819H2RS  
■ 04819H2AZ

RACING	HARNESSES
RACING	MECHANICS TECHNICAL
KARTING	SUITS UNDERWEAR
KARTING	SHOES / GLOVES PROTECTIONS
PERFORMANCE	SEATS HARNESSES STEERING WHEELS
e-SPORTS	SIM RACING CHAIRS
TEAMWEAR & LIFESTYLE	CLOTHING ACCESSORIES
TEAMWEAR & LIFESTYLE	CAPSULE COLLECTIONS
OUTLET	



# PRO H-9

HOMOLOGATION: FIA 8853-2016



MANUFACTURER: SPARCO  
MODEL: 04825H  
HOM. NO: SH.071.19-T-6  
FIA STANDARD: 8853-2016

## HIGHLIGHTS

- 6 point harness.
- 2" FHR specific straps.
- Compact T-bar.
- Aluminum buckle.
- Aluminum adjusters.
- Rollcage fasteners (shoulders and thigh) and ultra-light carabiner (abdominal).
- **WRC M-Sport Racing Team** and **WEC Peugeot Team** official harnesses equipment.



● 04825HNR  
● 04825HRS

# PRO H-8 ENDURANCE

HOMOLOGATION: FIA 8853-2016



MANUFACTURER: SPARCO  
MODEL: 04835H  
HOM. NO: SH.085.21-T-6  
FIA STANDARD: 8853-2016

## HIGHLIGHTS

- 6-point endurance belt.
- 2" Specific FHR shoulder straps.
- Compact T-bar.
- Aluminum buckle.
- Aluminum adjuster on shoulder straps.
- Steel adjuster on thigh and abdomen.
- Screw fasteners on all branches.
- Roll fixing bars for shoulder straps and leg harnesses.
- Official Dallara Stradale harness equipment.



04835HNR



RACING

RACING

KARTING

KARTING

PERFORMANCE

e-SPORTS

TEAMWEAR & LIFESTYLE

TEAMWEAR & LIFESTYLE

OUTLET

HARNESSES

MECHANICS TECHNICAL

SUITS UNDERWEAR

SHOES / GLOVES PROTECTIONS

SEATS HARNESSES STEERING WHEELS

SIM RACING CHAIRS

CLOTHING ACCESSORIES

CAPSULE COLLECTIONS



# COMPETITION H-3+2

HOMOLOGATION: FIA 8853-2016

## HIGHLIGHTS

- 6 point seat belt.
- 3" specific FHR shoulder straps with reduction to 2".
- Aluminum buckle.
- Steel shoulder and abdominal strap adjusters.
- Snap-hook fasteners on all straps.
- Possibility of fixing to rollcage on shoulder straps and leg loops by removing the accessories.



MANUFACTURER: SPARCO  
MODEL: 04818RH  
HOM. NO: SH.005.16-T-6  
FIA STANDARD: 8853-2016

- 04818RH1NR
- 04818RH1RS
- 04818RH1AZ



# COMPETITION H-2 PU

NEW

HOMOLOGATION: FIA 8853-2016

## HIGHLIGHTS

- 6 point harness.
- 2" FHR Shoulder straps.
- Compact Tbar.
- Aluminum buckle.
- Pull up adjustment on abdominals.
- Steel adjusters.
- Snap-on for all straps.



MANUFACTURER: SPARCO  
MODEL: 04821H  
HOM. NO: SH.019.17-T-6  
FIA STANDARD: 8853-2016

- 04821H1NR
- 04821H1RS
- 04821H1AZ



# COMPETITION H-3 STEEL

NEW

HOMOLOGATION: FIA 8853-2016

## HIGHLIGHTS

- 6 point harness.
- Aluminum buckle.
- PULLDOWN abdominal adjustment with integrated tongue.
- 3" straps with steel adjuster.
- Snap-on for all straps.



MANUFACTURER: SPARCO  
MODEL: 04834HPD  
HOM. NO: SH.076.20-T-6  
FIA STANDARD: 8853-2016

- 04834HPDRACNR
- 04834HPDRACRS
- 04834HPDRACAZ



# COMPETITION H-2 PD

HOMOLOGATION: FIA 8853-2016

## HIGHLIGHTS

- 6 point harness.
- 2" FHR specific straps.
- Aluminum buckle.
- High resistance steel shoulder and abdominal strap adjusters.
- Pull down adjustment on abdominals by integrated pull adjusters.
- Snap hooks or rollcage fixing by removing the accessories.
- Compact T-Bar.



MANUFACTURER: SPARCO  
MODEL: 04834HPD  
HOM. NO: SH.076.20-T-6  
FIA STANDARD: 8853-2016

- 04834HPDNR
- 04834HPDRS
- 04834HPDAZ



RACING

RACING

KARTING

KARTING

PERFORMANCE

e-SPORTS

TEAMWEAR & LIFESTYLE

TEAMWEAR & LIFESTYLE

OUTLET

HARNESSES

MECHANICS TECHNICAL

SUITS UNDERWEAR

SHOES / GLOVES PROTECTIONS

SEATS HARNESSES STEERING WHEELS

SIM RACING CHAIRS

CLOTHING ACCESSORIES

CAPSULE COLLECTIONS



# SPORT H-4

HOMOLOGATION: FIA 8854-1998



MANUFACTURER: SPARCO  
MODEL: 04716M  
HOM. NO: B-345.T/98  
FIA STANDARD: 8854-1998

## HIGHLIGHTS

- 4 point seat belt.
- 3" shoulder straps.
- Aluminum buckle.
- High resistance steel shoulder and abdominal strap adjusters.
- Snap-hook fasteners on all straps or rollcage fixing on shoulder straps by removing the accessories.



- 04716M1NR
- 04716M1RS
- 04716M1AZ

# SPORT H-5

SFI CAMO

HOMOLOGATION: SFI 16.1

## HIGHLIGHTS

- 5 point seat belt.
- 3" shoulder straps.
- Latch-n-link buckle.
- High resistance steel shoulder and abdominal strap adjusters.
- Ideal for off-road vehicles and/or boats.



04806SFIVDM

# SPORT H-5

SFI

HOMOLOGATION: SFI 16.1

# ACCESSORIES

HOMOLOGATION: FIA 8853-2016

## HIGHLIGHTS

- 5 point seat belt.
- 3" shoulder straps.
- Latch-n-link buckle.
- High resistance steel shoulder and abdominal strap adjusters.
- Ideal for off-road vehicles and/or boats.



- 04806SFINR
- 04806SFIVD

### PAIRS OF SHOULDER PADS

- Pair of pads for 3" harnesses. Made of padded velour. NOT FIREPROOF.



● 01098S3R



● 01098S3A



● 01098S3N

### EYEBOLT

Thread 7/16



04501

### REINFORCEMENT FIXING PLATE

Thread 7/16



04502



# DARFING STEERING WHEELS

## KAGUING



OUTLET	TEAMWEAR & LIFESTYLE	TEAMWEAR & LIFESTYLE	e-SPORTS	PERFORMANCE	KARTING	KARTING	RACING	RACING
	CAPSULE COLLECTIONS	CLOTHING ACCESSORIES	SIM RACING CHAIRS	SEATS HARNESSES STEERING WHEELS	SHOES / GLOVES PROTECTIONS	SUITS UNDERWEAR	MECHANICS TECHNICAL	STEERING WHEELS



# STEERING WHEELS INDEX

MADE IN ITALY

**F-10C**   
TYPE: FORMULA  
DIAMETER (MM): 270



015PC270SSN

**F-10A**   
TYPE: FORMULA  
DIAMETER (MM): 270



015P270SSN

**P310/P310 OPEN**   
TYPE: FORMULA / SALOON  
DIAMETER (MM): 310



015P310F2SN



015P3100PN

**P300**   
TYPE: FORMULA / SALOON  
DIAMETER (MM): 300



015P300SN

**R323**   
TYPE: RALLY / SALOON  
DIAMETER (MM): 270



015R323PSNR

**R330 / R330B**   
TYPE: FORMULA / SALOON  
DIAMETER (MM): 330



015R330CSO



015R330CLO



015R330PSO

**R350 / R350B**   
TYPE: FORMULA / SALOON  
DIAMETER (MM): 350



015R350CSO



015R350CLO



015R350PSO

**R215 / R215 FLAT**   
TYPE: RALLY  
DIAMETER (MM): 350



015R215CSN



015R215FL



015R215FS

**R325**   
TYPE: RALLY  
DIAMETER (MM): 350



015R325CSN

**R345**   
TYPE: RALLY  
DIAMETER (MM): 350



015R345MLN

**R368**   
TYPE: RALLY / OFF ROAD / TRUCK  
DIAMETER (MM): 380



015R368MSN

**R353**   
TYPE: RALLY / SALOON  
DIAMETER (MM): 330



015R353PSN

**R375**   
TYPE: RALLY / SALOON  
DIAMETER (MM): 350



015R375PSN

**R383 / R383 LOGO**   
TYPE: RALLY / SALOON  
DIAMETER (MM): 330



015R383PSN



015R383PSNLOGO



# F-10C

MATERIAL: SUEDE

## HIGHLIGHTS

- Carbon steering wheel for prototype single-seater and sports vehicle.
- Ergonomic grip, designed based on experience gained with the racing teams of the most prestigious motor manufacturers.
- Hole interaxis 3x50.8 mm.

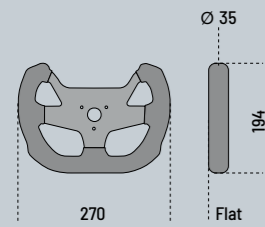

015PC270SSN



# P310

MATERIAL: SUEDE

## HIGHLIGHTS

- Flat steering wheel ideal for GT car.
- Hole interaxis: 6x70 mm.

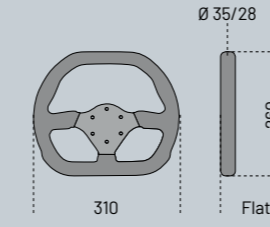

015P310F2SN



# F-10A

MATERIAL: SUEDE

## HIGHLIGHTS

- Aluminium steering wheel for prototype single-seater and sports vehicle.
- Ergonomic grip, designed based on experience gained with the racing teams of the most prestigious motor manufacturers.
- Hole interaxis 3x50.8 mm.

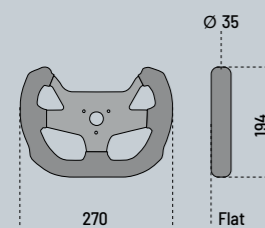

015P270SSN



# P310 OPEN

MATERIAL: SUEDE

## HIGHLIGHTS

- Open top, ideal for GT cars.
- Hole interaxis: 6x70 mm.



015P310OPN







# P300

MATERIAL: SUEDE

## HIGHLIGHTS

- Flat steering wheel with small grip.
- Hole interaxis: 6x70 mm.

New horn button colour kit included.



015P300SN



# R323

MATERIAL: SUEDE

## HIGHLIGHTS

- Flat steering wheel with small grip.
- Hole interaxis: 6x70 mm.

New horn button colour kit included.

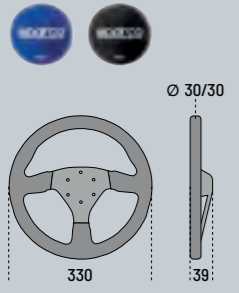

015R323PSNR



RACING	STEERING WHEELS
RACING	MECHANICS TECHNICAL
KARTING	SUITS UNDERWEAR
KARTING	SHOES / GLOVES PROTECTIONS
PERFORMANCE	SEATS HARNESSES STEERING WHEELS
e-SPORTS	SIM RACING CHAIRS
TEAMWEAR & LIFESTYLE	CLOTHING ACCESSORIES
TEAMWEAR & LIFESTYLE	CAPSULE COLLECTIONS
OUTLET	



# R330 / R330 B

MATERIAL: SUEDE / LEATHER

## HIGHLIGHTS

- Hole interaxis: 6x70 mm.

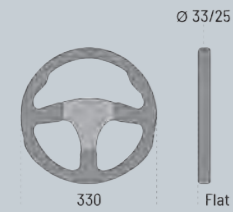

WITHOUT BUTTONS

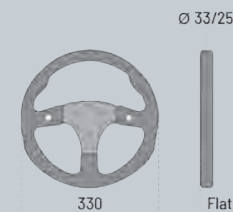

WITH BUTTONS

**015R330CLO**  
LEATHER WITHOUT BUTTONS



**015R330CSO**  
SUEDE WITHOUT BUTTONS



**015R330PSO**  
SUEDE + BUTTONS

- IP68 buttons for water and dust protection.

# R215

MATERIAL: SUEDE

## HIGHLIGHTS

- Dished steering wheel with lighter spokes.
- Hole interaxis: 6x70 mm.

New horn button colour kit included.

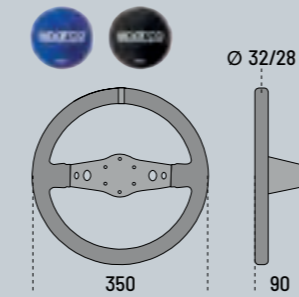

**015R215CSN**



# R350 / R350 B

MATERIAL: SUEDE / LEATHER

## HIGHLIGHTS

- Hole interaxis: 6x70 mm.

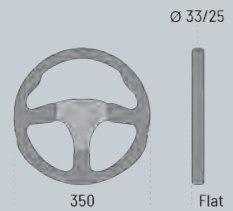

WITHOUT BUTTONS

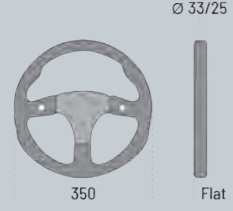

WITH BUTTONS

**015R350CLO**  
LEATHER WITHOUT BUTTONS



**015R350CSO**  
SUEDE WITHOUT BUTTONS



**015R350PSO**  
SUEDE + BUTTONS

- IP68 buttons for water and dust protection.

# R215 FLAT

MATERIAL: SUEDE / LEATHER

## HIGHLIGHTS

- Suede flat steering wheel for rally use.
- Hole interaxis: 6x70 mm.

New horn button colour kit included.

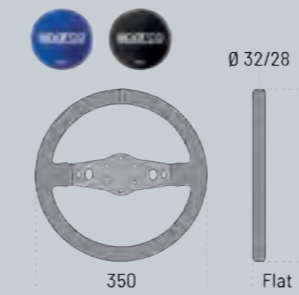

**015R215FL**  
LEATHER



**015R215FS**  
SUEDE



# R325

MATERIAL: SUEDE

## HIGHLIGHTS

- Dished steering wheel with three spokes and small grip.
- Hole interaxis: 6x70 mm.

New horn button colour kit included.

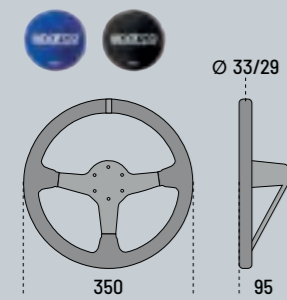

015R325CSN

# R368

MATERIAL: SUEDE

## HIGHLIGHTS

- Dished steering wheel optimal for off-road use.
- Hole interaxis: 6x70 mm.

New horn button colour kit included.

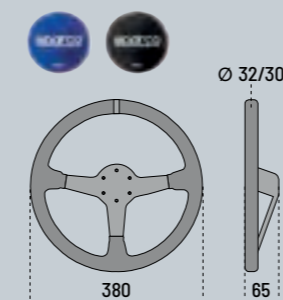

015R368MSN

# R345

MATERIAL: SUEDE / LEATHER

## HIGHLIGHTS

- Dished steering wheel with small grip.
- Hole interaxis: 6x70 mm.

New horn button colour kit included.

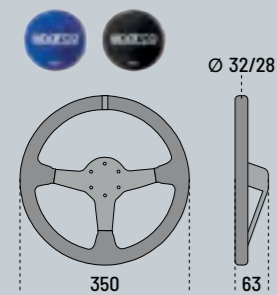

015R345MLN  
LEATHER

015R345MSN  
SUEDE





# R353

MATERIAL: SUEDE

## HIGHLIGHTS

- Dished steering wheel with large grip.
- Hole interaxis: 6x70 mm.

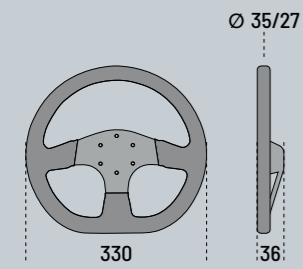

015R353PSN



# R383 LOGO

MATERIAL: SUEDE

## HIGHLIGHTS

- Steering wheel with special comfortable grip shape.
- Hole interaxis: 6x70 mm.

New horn button colour kit included.

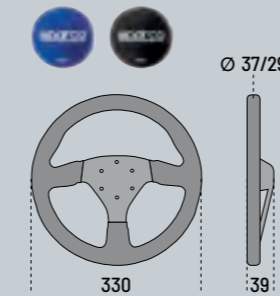

015R383PSNLOGO



# R375

MATERIAL: SUEDE

## HIGHLIGHTS

- Special 36 mm dished.
- Hole interaxis: 6x70 mm.

New horn button colour kit included.

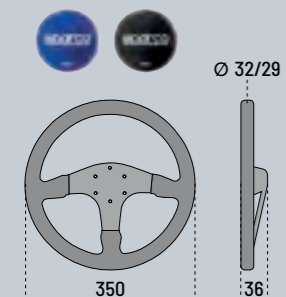

015R375PSN



# R383

MATERIAL: SUEDE

## HIGHLIGHTS

- Steering wheel with special comfortable grip shape.
- Hole interaxis: 6x70 mm.

New horn button colour kit included.

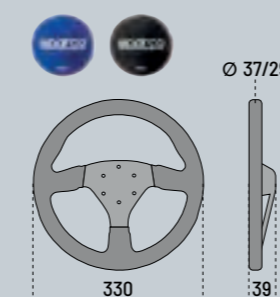

015R383PSN



RACING

RACING

KARTING

KARTING

PERFORMANCE

e-SPORTS

TEAMWEAR & LIFESTYLE

TEAMWEAR & LIFESTYLE

OUTLET

STEERING WHEELS

MECHANICS TECHNICAL

SUITS UNDERWEAR

SHOES / GLOVES PROTECTIONS

SEATS HARNESSES STEERING WHEELS

SIM RACING CHAIRS

CLOTHING ACCESSORIES

CAPSULE COLLECTIONS



# ACCESSORIES

## PRE-WIRED QUICK RELEASE

- Wire harness with silver solder connection with LEMO connectors from F1.
- CNC machined aircraft aluminum.
- Hard anodizing for strength and reliability.
- Drilling for assembly 6x70mm.
- FIA compliant (Annex J).



015R98EL

## QUICK RELEASE

- CNC processed aeronautical aluminium.
- Hard anodised for resistance and reliability.
- Slots for 6x70 mm mount.
- FIA compliant (annex J).



015R98R

## SW PAD

Steering wheel protection pad.  
FIA compliant (annex J).



015002NR



## HORN DELETE KIT

HORN DELETE KIT MATT



0159ZMNR

HORN DELETE KIT GLOSSY



0159ZNR



## RING



01599NR

## ANODIZED STEERING WHEEL SPACERS

ANODIZED ALUMINIUM



01595ANR



01595ANT

## RACING PUSH BUTTONS KIT



015NE981

015NE982



## STEEL WHEEL HUB

FOR THE APPLICATION LIST  
PLEASE CHECK PRICE LIST.

Sparco collapsible hubs are made from cast iron with a steel frame that collapse during impacts. This item absorbs kinetics energy avoiding transfer to the driver.

The Sparco steering wheels are TÜV approved only if coupled with the Sparco hubs.



RACING	STEERING WHEELS
RACING	MECHANICS TECHNICAL
KARTING	SUITS UNDERWEAR
KARTING	SHOES / GLOVES PROTECTIONS
PERFORMANCE	SEATS HARNESSES STEERING WHEELS
e-SPORTS	SIM RACING CHAIRS
TEAMWEAR & LIFESTYLE	CLOTHING ACCESSORIES
TEAMWEAR & LIFESTYLE	CAPSULE COLLECTIONS
OUTLET	



# D A P I N G M E C H A N I C S T E C H N I C A L K A L L I N U S



TEAMWEAR & LIFESTYLE	CAPSULE COLLECTIONS
TEAMWEAR & LIFESTYLE	CLOTHING ACCESSORIES
e-SPORTS	SIM RACING CHAIRS
PERFORMANCE	SEATS HARNESSES STEERING WHEELS
KARTING	SHOES / GLOVES PROTECTIONS
KARTING	SUITS UNDERWEAR
RACING	MECHANICS TECHNICAL
OUTLET	



# FIA 8867-2016

## JACKET AND PANTS

**HOMOLOGATION:** FIA 8867-2016 - (SFI 3.4/5 ON DEMAND)  
**SIZES:** S-XXL



MANUFACTURER: SPARCO  
MODEL: RMO-003  
HOM. NO: MO.006.22  
FIA STANDARD: 8867-2016

# MS-5

**HOMOLOGATION:** NOT HOMOLOGATED  
**SIZES:** S-XXL **COMPOSITION:** 70% POLYESTER, 30% COTTON

### HIGHLIGHTS



3 layer construction.



Stretch back panel.



Side pockets.



002023J..



002023P..

### HIGHLIGHTS



Reinforced elbow material.



Elasticated back panel.



Removable kneepads.



002019NR..



002019GR..

RACING

MECHANICS

KARTING

SUITS UNDERWEAR

KARTING

SHOES / GLOVES PROTECTIONS

PERFORMANCE

SEATS HARNESSES STEERING WHEELS

e-SPORTS

SIM RACING CHAIRS

TEAMWEAR & LIFESTYLE

CLOTHING ACCESSORIES

TEAMWEAR & LIFESTYLE

CAPSULE COLLECTIONS

OUTLET



# MS-4

**HOMOLOGATION:** NOT HOMOLOGATED  
**SIZES:** S-XXL **COMPOSITION:** 85% POLYESTER, 15% COTTON

## HIGHLIGHTS



Front pocket.



Elasticated band.



Side pockets.



002020AZ..



002020RS..

002020NR..

002020NR..



RACING	MECHANICS
KARTING	SUITS UNDERWEAR
KARTING	SHOES / GLOVES PROTECTIONS
PERFORMANCE	SEATS HARNESSES STEERING WHEELS
e-SPORTS	SIM RACING CHAIRS
TEAMWEAR & LIFESTYLE	CLOTHING ACCESSORIES
TEAMWEAR & LIFESTYLE	CAPSULE COLLECTIONS
OUTLET	



# FAST

**HOMOLOGATION:** FIA 8856-2018 - SFI 3.3/5  
**SIZES:** 38-48 **CUSTOMIZATION:** ON DEMAND



MANUFACTURER: SPARCO  
MODEL: MB FAST  
HOM. NO: DC.334.23-Z  
FIA STANDARD: 8856-2018

# TORQUE

**01 CERTIFICATION** (EN ISO 20347:2012)  
**SIZES:** 37-47 METAL FREE

## HIGHLIGHTS

- Breathable lining.
- Inner shock-absorber insole.



Genuine perforated leather upper and suede reinforcement areas.



Padded ankle for more support.



Rubber and phylon sole for maximum grip and comfort.



0012A6..NRBI

## HIGHLIGHTS

- Breathable mesh lining.
- Easy lacing.
- Phylon sole and oil and hydrocarbon resistant rubber bottom.
- SRA level slip resistance.



Tip with ultra-resistant coated reinforcement.



Energy absorption heel.

Ultra-lightweight and breathable OCCUPATIONAL footwear.



001289..NRAZ



001289..NRNR

RACING

KARTING

KARTING

PERFORMANCE

e-SPORTS

TEAMWEAR & LIFESTYLE

TEAMWEAR & LIFESTYLE

OUTLET

MECHANICS

SUITS UNDERWEAR

SHOES / GLOVES PROTECTIONS

SEATS HARNESSES STEERING WHEELS

SIM RACING CHAIRS

CLOTHING ACCESSORIES

CAPSULE COLLECTIONS



**HOMOLOGATION:** FIA 8856-2018  
**SIZES:** 8-15



MANUFACTURER: SPARCO  
MODEL: R-TIDE MECA  
HOM. NO: DC.302.23-G  
FIA STANDARD: 8856-2018

**HOMOLOGATION:** FIA 8856-2018  
**SIZES:** 9-13



MANUFACTURER: SPARCO  
MODEL: R-MECA V02  
HOM. NO: DC.355.23-G  
FIA STANDARD: 8856-2018

## HIGHLIGHTS

- Increased padded reinforcement on knuckles for maximum protection.
- Aramide knit knuckle reinforcement with silicone coating.
- Ergonomic pre-curved construction.
- Internal seams.



Palm with HTX 3D print vulcano with differentiated zones for maximum grip to absorb vibrations.



Fully ribbed cuff for maximum fit.

Compliant to the new FIA 8856-2018 heat transmission requirements.



001321..GF



001321..NR

## HIGHLIGHTS

- Aramide knit knuckle and finger reinforcement with silicone coating.
- Thumb reinforcement for maximum cut and abrasion protection.
- Internal seams.



Silicone palm with ultragrip texture.



Fully ribbed cuff for maximum fit.

Compliant to the new FIA 8856-2018 heat transmission requirements.



001317..GF



001317..NR





# MECA III

**SIZES:** S-XL  
**COMPOSITION:** 47% POLYESTER 35% SUEDE 18% ELASTANE

## HIGHLIGHTS

- The backs of Meca-3 gloves are made from elasticised, printed, scuff resistant fabric.
- The palms are in synthetic, scuff resistant hide and there are reinforcements positioned between thumb and index finger.
- Pads between the fingers provide better breathing.
- Strap for tighter fitting.



002093NRGF



002093BMAF



002093AZ



002093NR



002093RS

# SPORTAC PROTECTIVE GLOVES

**SIZES:** 8-11  
**CERTIFICATION:** PPE CAT.2 / EN 388:2016 / EN ISO 21420

## HIGHLIGHTS

- Adamant® diamond structure for a maximum level of cutting resistance.
- Exceptional comfort and dexterity.
- Palm resistant to grease and wet grime.
- Impact resistant on the back.
- Shock absorbing structure on the palm of the hand.



002097.GI

**PPE CATEGORY II:** Synthetic glove protecting against mechanical risks.

**ABRASION RESISTANCE:** 4 (performance levels).

**RESISTANCE TO BLADE CUTTING:** Coupe test: X (not done).

**TEAR RESISTANCE:** 4 (performance levels).

**PUNCTURE RESISTANCE:** 3 (performance levels).

**RESISTANCE TO CUTTING BY BLADE EN ISO 13997:** D (performance levels).

**EN PROTECTION AGAINST IMPACTS:** P (performance level).





## TECH SOFT-SHELL

**SIZES:** XS-3XL  
**COMPOSITION:** Outside 93% polyester, 7% spandex - Inside 100% polyester, 330 gsm

NEW



02412NRAF..



02412BMAZ..



02412GSGF..



02412BMAF..



02412NRGS..

## TECH HOODED FULL ZIP

**SIZES:** XS-3XL  
**COMPOSITION:** 80% cotton, 20% polyester, 280 gsm

NEW



02414NRAF..



02414BMAZ..



02414GSGF..



02414BMAF..



02414NRGS..

## TECH LIGHT-SHELL

**SIZES:** XS-3XL  
**COMPOSITION:** 90% nylon, 10% spandex, 240 gsm

NEW



02413NRAF..



02413BMAZ..



02413GSGF..



02413BMAF..



02413NRGS..

## NEW TECH FULL ZIP

**SIZES:** XS-3XL  
**COMPOSITION:** 80% cotton, 20% polyester, 260 gsm



02429BMAF..



02429BMAZ..



02429GSGF..



02429NRAF..



02429NRGS..



# WORKWEAR TECH

## TECH LIGHT VEST

**SIZES:** XS-3XL  
**COMPOSITION:** 90% nylon, 10% spandex, 240 gsm

NEW



02419NRAF..



02419BMAZ.. 02419GSGF..



02419BMAF.. 02419NRGS..

## NEW TECH DENIM JEANS

**SIZES:** XS-3XL  
**COMPOSITION:** 98% cotton, 2% spandex, 250 gsm



02430BS..

## TECH POLO

**SIZES:** XS-3XL  
**COMPOSITION:** 65% cotton, 35% polyester with piquè effect, 180 gsm

NEW



02415NRAF..



02415BMAZ.. 02415BMAF..



02415NRGS.. 02415GSGF..

## TECH T-SHIRT

**SIZES:** XS-3XL  
**COMPOSITION:** 50% cotton, 50% polyester with piquè effect, 180 gsm

NEW



02416NRAF..



02416BMAZ.. 02416GSGF..



02416BMAF.. 02416NRGS..



# WORKWEAR TECH

## TECH TROUSERS

**SIZES:** XS-3XL  
**COMPOSITION:** 90% nylon, 10% spandex, 240 gsm

NEW



02417NRAF..



02417NRAZ..



02417GSGF..



02417BMAF..



02417NRGS..

## NEW TECH LIGHT TROUSERS

**SIZES:** XS-3XL  
**COMPOSITION:** 90% nylon, 10% spandex, 170 gsm



02425GSGF..



02425NRAZ..



02425BMAF..



02425NRAF..



02417NRGS..

## TECH SHORTS

**SIZES:** XS-3XL  
**COMPOSITION:** 90% nylon, 10% spandex, 240 gsm



02418GSGF..



02418NRAZ..



02418NRGS..



02418BMAF..



02418NRGS..

## NEW TECH LIGHT SHORTS

**SIZES:** XS-3XL  
**COMPOSITION:** 90% nylon, 10% spandex, 170 gsm



02428GSGF..



02428NRAZ..



02428BMAF..



02428NRAF..



02428NRGS..



## BOSTON - CARGO MULTISEASON

**SIZES:** S-XXL

**COMPOSITION:** 98% drill cotton, 2% elastane, 260/270 gsm



02400GS..



02400NR..

## BERMUDA

**SIZES:** S-XXL

**COMPOSITION:**

97% cotton, 3% elastane, 220 gsm



02410GS..



02410NR..

## TOOLS BELT

**SIZES:** M-XL

Radio belts,  
adjustable with snap buckle.



**M-L**  
min 90 - max 120 cm **016451ML**

**L-XL**  
min 120 - max 150 cm **016451LXL**





MADE IN ITALY

FIA 8865

**014777EXP**   
**ACTIVATION:** ELECTRIC  
**TYPE:** RALLY/CIRCUIT  
**CAPACITY (LT.):** 3,9  
**WEIGHT (KG.):** 5,9



014777EXP

**014779EXP**   
**ACTIVATION:** ELECTRIC  
**TYPE:** RALLY/CIRCUIT  
**CAPACITY (LT.):** 2,5  
**WEIGHT (KG.):** 5,9



014779EXP

**014778EXL2 SP205**   
**ACTIVATION:** ELECTRIC  
**TYPE:** RALLY/CIRCUIT  
**CAPACITY (LT.):** 2,5  
**WEIGHT (KG.):** 3,9



014778EXL2

**014778EXL3 SP305**   
**ACTIVATION:** ELECTRIC  
**TYPE:** RALLY/CIRCUIT  
**CAPACITY (LT.):** 3,9  
**WEIGHT (KG.):** 5,1



014778EXL3

**014772FEAL**   
**ACTIVATION:** ELECTRIC  
**TYPE:** FORMULA  
**CAPACITY (LT.):** 0,9  
**WEIGHT (KG.):** 1,8



014772FEAL

FIA 2000

**014772EXL**   
**ACTIVATION:** ELECTRIC  
**TYPE:** RALLY/CIRCUIT  
**CAPACITY (LT.):** 4,25  
**WEIGHT (KG.):** 6,7



014772EXL

**014772MSL**   
**ACTIVATION:** MECHANIC  
**TYPE:** RALLY/CIRCUIT  
**CAPACITY (LT.):** 4,25  
**WEIGHT (KG.):** 8,1



014772MSL

ART. 253/J

**014773BXLN2**   
**ACTIVATION:** HAND HELD  
**TYPE:** RALLY  
**CAPACITY (LT.):** 2  
**WEIGHT (KG.):** 3,4



014773BXLN2

**014773BXL24**   
**ACTIVATION:** HAND HELD  
**TYPE:** RALLY  
**CAPACITY (LT.):** 2,4  
**WEIGHT (KG.):** 4,5



014773BXL24

EN3

**014773BSS2**   
**ACTIVATION:** HAND HELD  
**TYPE:** RALLY  
**CAPACITY (LT.):** 2  
**WEIGHT (KG.):** 2,8



014773BSS2

PERFORMANCE

PG. 329

**014775BXL2**   
**ACTIVATION:** HAND HELD  
**TYPE:** RALLY  
**CAPACITY (LT.):** 2  
**WEIGHT (KG.):** 2,8



014775BXL2

OUTLET	TEAMWEAR & LIFESTYLE	TEAMWEAR & LIFESTYLE	e-SPORTS	PERFORMANCE	KARTING	KARTING	KARTING	TECHNICAL
	CAPSULE COLLECTIONS	CLOTHING ACCESSORIES	SIM RACING CHAIRS	SEATS HARNESSES STEERING WHEELS	SHOES / GLOVES PROTECTIONS	SUITS UNDERWEAR	RACING	



## HIGHLIGHTS

- FIA (8865-2015) approved pressurised extinguishing system.
- 4.3 Kg of FK-5-1-12 extinguishing agent.
- Electric ignition.
- 3.9 L stainless steel tank diameter 130mm length 346 mm.
- 1 Cockpit nozzle + 1 engine nozzle.
- For 2.3m<sup>3</sup> - 4.1m<sup>3</sup> cockpits.



014777EXP

## ACCESSORIES



MA0142131  
+ MA0142098



MA0142107



MA0142108



MA0142109



MA0142117



MA0142122



MA0142127



MA0142128 - MA0142129



MA0142133



MA0142134



MA0142135



MA0142023



MA0142163

## HIGHLIGHTS

- FIA (8865-2015) approved pressurised extinguishing system.
- 3.3 Kg of FK-5-1-12 extinguishing agent.
- Electric activation.
- 2.5L stainless steel tank diameter 114mm, length 302 mm.
- 1 Cockpit nozzle + 1 engine nozzle.
- For 1.2m<sup>3</sup> - 2.3m<sup>3</sup> volume cockpits.



014779EXP

## ACCESSORIES



MA0142131  
+ MA0142098



MA0142107



MA0142109



MA0142117



MA0142122



MA0142127



MA0142128 - MA0142129



MA0142133



MA0142134



MA0142135



MA0142023



MA0142163



## HIGHLIGHTS

- Electrically operated ultra-light extinguishing system.
- 2.5L stainless steel tank diameter 110mm, length 302 mm.
- AFFF extinguishing agent (2 litres).
- Bullet nozzles.
- Full metal fittings.



014778EXL2

## ACCESSORIES



MA0142103  
+ MA0142082



MA0142040



MA0142041



MA0142042



MA0142043



MA0142029



MA0142163



MA0142030



MA0142023

## HIGHLIGHTS

- Electrically operated ultra-light extinguishing system.
- 3.9L stainless steel tank. diameter 130mm length 346 mm.
- AFFF extinguishing agent (3 litres).
- Bullet nozzles.
- Full metal fittings.



014778EXL3

## ACCESSORIES



MA0142131  
+ MA0142098



MA0142040



MA0142041



MA0142042



MA0142043



MA0142029



MA0142163



MA0142030



MA0142023



## HIGHLIGHTS

- 1.3 litre aluminium single-seater extinguishing system.
- Dimension: diameter 106mm length 190mm.
- AFFF extinguishing agent (0.9 litres).
- Pressurised to 16 Bar.
- Solid block-machined nozzles, all-metal connectors.



014772FEAL

## ACCESSORIES



MA0142042



MA0142040



MA0142043



MA0142041



MA0142083  
MA0142082

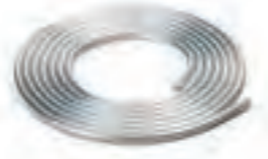

MA0142029



MA0142163



MA0142023



MA0142030

## HIGHLIGHTS

- Ultra-light, electrically activated extinguisher system.
- Dimension: diameter 160mm length 330mm.
- CE certified bottle in stainless steel (tested at over 40 Bar).
- AFFF foam extinguisher (4.25 litres).
- Solid block-machined nozzles, all-metal connectors.



014772EXL

## ACCESSORIES



MA0142042



MA0142040



MA0142043



MA0142041



MA0142013  
MA0142049  
MA01480



MA0142029



MA0142163



MA0142023



MA0142030



## HIGHLIGHTS

- Mechanically activated extinguisher system.
- Dimension: diameter 160mm length 330mm.
- CE certified bottle in steel (tested at over 40 Bar). AFFF foam extinguisher (4.25 litres).
- Solid block-machined nozzles, all-metal connectors.



014772MSL

### 014773BXLN2

- Ultra-light FIA approved extinguisher.
- 2 litre Novec extinguishing agent.

014773BXLN2



### 014773BXL24

- Ultra-light FIA approved extinguisher.
- 2.4 litre AFFF extinguishing agent.
- 3.9 litre stainless steel cylinder (h 345 mm diameter 130).

014773BXL24



### 014773BSS2

- Hand-held extinguisher 2.0 kg EN3 compliant powder.
- Complete with 2 brackets.
- Ultra-light FIA approved extinguisher.

014773BSS2



## ACCESSORIES



MA0142042



MA0142040



MA0142043



MA0142041



MA0142013  
MA0142049  
MA01480



MA0142029



MA014RL24CL



MA0142023



**FEATURES:** Passage adhering to the body shell wherever possible. Accurate manufacturing. Specific boxed reinforcements. Made with certified material. Front suspension fixing points on some models.

- **1A** Multipoint welded-in, 25CrMo4 with front suspension fixing points.
- **1B** Multipoint welded-in, Fe45 with front suspension fixing points.
- **2A** Multipoint built-in, 25CrMo4 with front suspension fixing points.
- **2B** Multipoint built-in, Fe45 with front suspension fixing points.
- **3A** 25CrMo4 roll cage without front suspension fixing points.
- **3B** Fe45 roll cage without front suspension fixing points.
- **3C** Weld-in roll cage without front suspension point.
- **4** Roll cages with door bars Fe 45.

**FOR THE COMPLETE APPLICATION LIST PLEASE CHECK PRICE LIST.**

● **1A - 1B**



● **3A - 3B - 3C**



● **2A - 2B**



● **4**



## RACING START ADAPTATION KIT



**00780KS**

- 2 tubes L 1200 mm Ø40X2, pins welded on one side
- 4 M10 screws
- 4 x M10 self-locking nuts
- 4 forks
- 2 plugs

Racing start kit is proposed to upgrade the existing Appendix J roll cages. This kit is composed of 6 tubes to build up the cross reinforcement for the roof and the main roll bar, complete with reinforcement gussets.

- 2 tubes L 1200 mm Ø40X2
- 4 shaped tubes L100 Ø40X2
- 4 sleeves L200 Ø45X2
- 8 M10 screws
- 8 x M10 nuts



**00797**

**007971**

## DOOR BARS KITS

## ROLL BAR PADDINGS



As from 01.01.2003 FIA-approved padding has become compulsory in all types of races and cars, Sparco supplies a material certified in accordance with FIA regulation 8857-2001. in different choices of length and diameter. The paddings are fitted to the roll cages in all possible points of contact with driver with harnesses fastened.



**0076050**

Ø 50 mm - 500 mm - 122 g - Set 2 pcs



**0076045**

Ø 45 mm - 500 mm - 131 g - Set 2 pcs



**0076040**

Ø 40 mm - 500 mm - 129 g - Set 2 pcs



**0076035**

Ø 35 mm - 500 mm - 135 g - Set 2 pcs



## ROLL CAGE FORK



Ø 40 mm **0078140S**  
Ø 50 mm **0078150S**

Fork for tubes' assembly, using plug + fork system (tube diameter 40 mm) (tube diameter 50 mm).

## ROLL CAGE PLUGS



**00780M**

Pair of perforated sleeves (diameter 45 mm) for tubes' assembly.

## REINFORCEMENT PLATES + COUNTERPLATES FIA 2010 UPDATING KIT



**00780P**

Kit composed of 4x perforated plates + 4x flat counter plates (3 mm thick). These plates must be adapted in according to the different configurations of roll cages or body shells and allow to update the roll cage fixing in accordance with 2010 FIA regulation.

## UNIVERSAL GUSSET KIT FOR ROOF



**00798SP1**

Kit composed of 2x universal reinforcement gussets to be mounted on the tubes' cross joint (dimensions 190x85 mm). This is a universal kit so it's could be necessary for the user to adapt it to his own roll cage.

## UNIVERSAL GUSSET KIT FOR DOORBAR CROSS



**00798SP2**

Kit composed of 4x universal reinforcement gussets to be mounted on the tubes' cross joint (dimensions 100x170 mm). This is a universal kit so it's could be necessary for the user to adapt it to his own roll cage.

## ROLL CAGE PLUG



**00782NTS**

Forged plug for tubes' assembly, using plug + fork system.



# ACCESSORIES

## NEW DRIVER FOOTREST PRO

03814AN1

3mm thick non-slip checkerboard aluminium.

Double plate (lower and upper) for fixing to the floor and adjusting the inclination of the upper plate (4 inclinations available).

Perforations for lightening with anti-tear embossing.

Lower plate with slots to adapt to any type of floor drilling".

Dimensions:  
270x43x136mm



## NEW CODRIVER FOOTREST PRO

03814AN2

3mm thick non-slip checkerboard aluminium.

Double plate (lower and upper) for fixing to the floor and adjusting the inclination.

Lower plate with slots.

Dimensions:  
270x43x136mm



## PEDAL SETS

03783L



3-piece set in pre-bent and shaped mixed carbon. Brake and clutch with non-slip inserts.

## KIT OF 8 STICKERS

ASPA002



## BONNET PINS

Pair of stainless steel bonnet pins with captive slide pin.



01606S

01606AA

01606AR

01608

# ACCESSORIES

## FUEL CAPS

270040A



With key.

270050A



Without key.

## HAMMERS

01615



01613



Hammer with seatbelt cutter built-in.

## AERO FUEL CAP

27009G



## BATTERY MASTER SWITCH

01337



Battery master switch with rotating lever. Instant disconnection of all electric circuits. Provision for remote control. Complies with FIA spec. Suitable for 6, 12 and 24V systems, rated at 100A continuous.

01336



Bipolar master battery cutout switch with rotating lever. Instant disconnection of master electric circuit. Provision for remote control. Suitable for 6, 12 and 24V systems, rated at 100A continuous.



# TYRE WARMERS

# RACING NETS

For the application list please check price list.



- 2980SPNR
- 2980SPRS
- 2980SPAZ

## PIT SIGNAL BOARD

Pit signal kit.  
**00594**



Cover.  
**00594C**  
Number sets.  
**00592/1**  
Pit board.  
**00594T**



4row reflection-proof black aluminium frame.

## FIA 8863-2013 APPROVED WINDOW NET SPECIFICALLY FOR TRACK USE

Seat side fixing with 1" belts and 2 bar adjusters for fixing to rollbar.  
Dashboard side fixing with optional double use:  
- Quick release fixing with 1" strap.  
- Quick release fixing 2" strap and spring-operated adjuster for better net tension.

**002193NR**

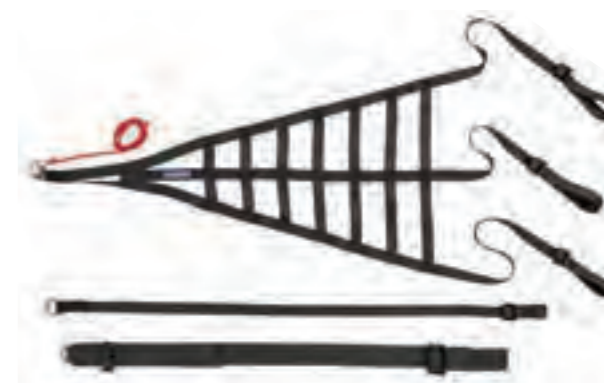

Seat side fixing with 1" belts and 2 bar adjusters for fixing to rollbar.  
Dashboard side fixing with optional double use:  
- Quick release fixing with 1" strap.  
- Quick release fixing 2" strap and spring-operated adjuster for better net tension.  
- Pelican hook system that allows the pre-tensioning of the net as prescribed by the FIA standard.

**002194NR**

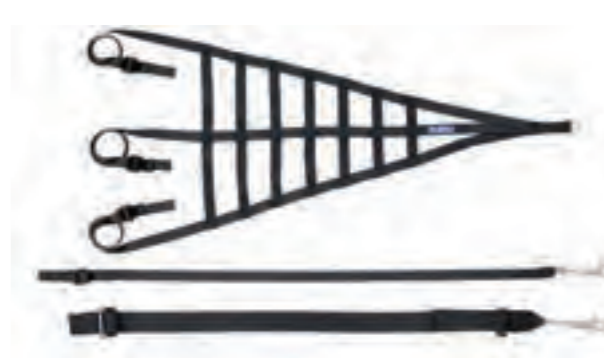

## NEW WINDOW NET SPECIFIC FOR T-SERIES

Compliant with FIA Art.253 annex J.  
Dimensions: 100 x 50 cm.  
Strap fastening on all sides.

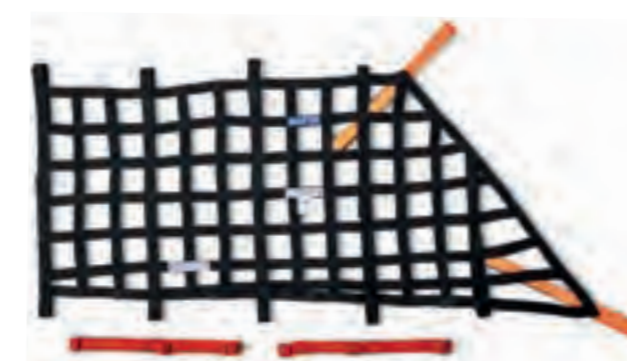

**002198FA-NR**

## WINDOW NETS

In compliance with FIA annex J 253.  
Dimensions: L. 50 cm, H. 52 cm.  
Tape for quick fastening to roll bar.

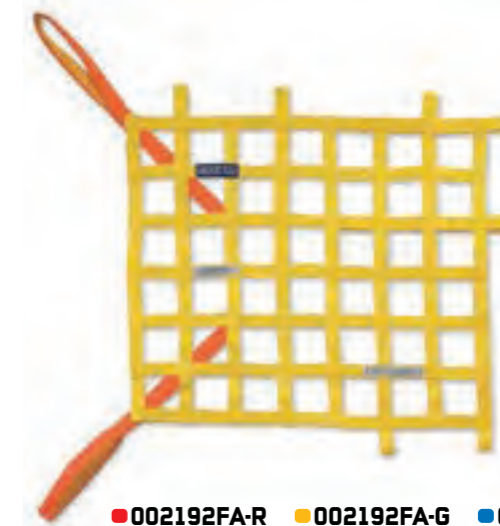

● 002192FA-R ● 002192FA-G ● 002192FA-BM



# ACCESSORIES

## ANALOG PRESSURE GAUGE

Ø 63 mm

Scale 0-4 bar, aluminium handle, rubber cap, high-precision recording.



2941063A

Ø 100 mm



29410100A

## DIGITAL PRESSURE GAUGE

Ø 63 mm

Scale 0-4 bar, aluminium handle, rubber cap, high-precision recording.



2941063D

## CIRCUIT/RALLY STOP-WATCH



29424103

## MAPLIGHTS

Led Reading Lamp, length 49 cm, flexible tube, 12V.



01628

## ROAD BOOK



03725

# ACCESSORIES

## RACERS TAPE



**0169550**  
Transparent, scratchproof adhesive tape. Roll 50 mm wide x50 m.

**01691**  
All-purpose heavy duty racer tape. Roll 50 mm wide x50 metres. 7 different colours.

**01692**  
Aluminised tape. Roll 50 mm wide x50 m.

Universal spare wheel fastening with high-strength tape, complete with locking ratchet, 3 eyebolts and 3 fixing plates.

03773



Cross-key fixing.

03776



## STEEL TOWBARS FIA

50 mm

FIA annex J 253 compliant.



01627RS50

80 mm

FIA annex J 253 compliant.



01627RS80

## TOW STRAP FIA

FIA annex J 253 compliant.



01637RS

## TOW STRAP (NOT FIA APPROVED)

Hole diameter: 15 mm.



● 01638NR

● 01638AZ

● 01638ARF

● 01638GF



# KARTING



MAIN KARTING PARTNERS:



TEAMWEAR & LIFESTYLE	CAPSULE COLLECTIONS
TEAMWEAR & LIFESTYLE	CLOTHING ACCESSORIES
e-SPORTS	SIM RACING CHAIRS
PERFORMANCE	SEATS, HARNESSES, STEERING WHEELS
KARTING	SHOES / GLOVES, PROTECTIONS
KARTING	SUITS, UNDERWEAR



# MARTINA SUITS WALK UUUU



TEAMWEAR & LIFESTYLE	CAPSULE COLLECTIONS
TEAMWEAR & LIFESTYLE	CLOTHING ACCESSORIES
e-SPORTS	SIM RACING CHAIRS
PERFORMANCE	SEATS HARNESSES STEERING WHEELS
KARTING	SHOES / GLOVES PROTECTIONS
KARTING	SUITS
OUTLET	



MADE IN ITALY

**PRIME K / PRIME K YOUTH 8877-2022** NEW  
**ADVANCED**

**HOMOLOGATION:**  
 FIA 8877-2022  
**SIZES:** 44-62 **YOUTH SIZE:** 120-150  
**CUSTOMIZATION:**  
 ON DEMAND



002310..EBNR 002310..NRGF 002310..NRGR 002310..NRRS

**X-LIGHT / X-LIGHT YOUTH**

**HOMOLOGATION:**  
 CIK-FIA 2013-1  
**SIZES:** 44-62 **YOUTH SIZE:** 120-150  
**CUSTOMIZATION:**  
 CUSTOM EASY ON DEMAND



002309BGFN.. 002309NRBI.. 002309NGGF.. 002309NBR5..

**KERB / KERB YOUTH**

**HOMOLOGATION:**  
 CIK-FIA 2013-1  
**SIZES:** XS-XXL  
**YOUTH SIZE:** 120-150  
**CUSTOMIZATION:**  
 BY STOCK



002341RNBO.. 002341BNGB.. 002341BNBV.. 002341GNBG.. 002341NAFB.. 002341NBR5..

**KERB LADY / KERB YOUTH**

**HOMOLOGATION:**  
 CIK-FIA 2013-1  
**SIZES:** XS-XXL **YOUTH SIZE:** 120-150  
**CUSTOMIZATION:**  
 BY STOCK



002341LNRBF.. 002341LNRGF..

**THUNDER / THUNDER YOUTH**

**HOMOLOGATION:**  
 CIK-FIA 2013-1  
**SIZES:** XS-XXL  
**YOUTH SIZE:** 120-150  
**CUSTOMIZATION:**  
 BY STOCK



002342RSNR.. 002342GSGF.. 002342NRAF.. 002342NRRS.. 002342NRAZ.. 002342BSGF 002342NRVF..

**ROOKIE / ROOKIE YOUTH**

**HOMOLOGATION:**  
 NOT HOMOLOGATED  
**SIZES:** XS-XXL  
**YOUTH SIZE:** 120-150  
**CUSTOMIZATION:**  
 NOT CUSTOMIZABLE



002343NRGF.. 002343NREB.. 002343NRRS..



**Devin Walz**  
 BABY RACE DRIVER ACADEMY  
 WSK MINI Gr.3 runner-up

KARTING	SUITS
KARTING	SHOES / GLOVES PROTECTIONS
PERFORMANCE	SEATS HARNESSES STEERING WHEELS
e-SPORTS	SIM RACING CHAIRS
TEAMWEAR & LIFESTYLE	CLOTHING ACCESSORIES
TEAMWEAR & LIFESTYLE	CAPSULE COLLECTIONS
OUTLET	



# PRIME K / PRIME K YOUTH 8877-2022

ADVANCED

NEW

HOMOLOGATION: 8877-2022  
SIZES: 44-62 YOUTH SIZES: 120-150  
CUSTOMIZATION: FULLY PRINTABLE



MANUFACTURER: SPARCO  
MODEL: K46  
HOM. NO: KC.005.23-O  
FIA STANDARD: 8877-2022



## HIGHLIGHTS



Abrasion resistant back protection.  
Elasticized back panel.



Durable, lightweight and fully printed fabric.



Breathable and perforated fabric inserts.



002310..EBNR



002310..NRGF



002310..NRGR



002310..NRRS

KARTING

KARTING  
SHOES / GLOVES  
PROTECTIONS

PERFORMANCE  
SEATS  
HARNESSES  
STEERING WHEELS

e-SPORTS  
SIM RACING  
CHAIRS

TEAMWEAR  
& LIFESTYLE  
CLOTHING  
ACCESSORIES

TEAMWEAR  
& LIFESTYLE  
CAPSULE  
COLLECTIONS

OUTLET



**HOMOLOGATION:** CIK-FIA N2013.1  
**SIZES:** 44-62 **YOUTH SIZES:** 120-150  
**CUSTOMIZATION:** CUSTOM EASY - ON DEMAND

MANUFACTURER: SPARCO  
MODEL: K45  
HOM. NO: CIK-FIA 2013/055  
FIA STANDARD: N 2013-1

**R. Lammers**  
PAROLIN RACING KART  
2023 FIA European OK Champion



## HIGHLIGHTS



Hybrid construction with fully printed inserts.

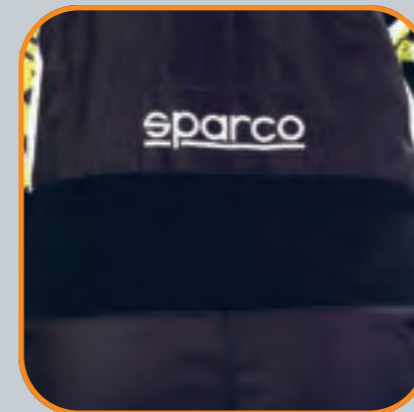

Elasticated anti abrasion back panel.



Ergonomic impact-absorbing padding (on the outside elbow and inside knee).



002309NGGF..



002309BGFN..



002309NBR..



002309NRBI..



**HOMOLOGATION:** CIK-FIA N2013.1  
**MAN SIZES:** XS-XXL **LADY SIZES:** XXS-L  
**YOUTH SIZES:** 120-150 **CUSTOMIZATION:** BY STOCK

**MANUFACTURER:** SPARCO  
**MODEL:** K44 KERB  
**HOM. NO:** CIK-FIA 2013/047  
**FIA STANDARD:** N 2013-1

**B. E. Yildirim**  
MODENA KART - PAROLIN RACING KART  
WSK Euro Series 2023 DKN Champion



## HIGHLIGHTS



Breathable inserts on inside leg and underarm.



Elasticated back panel.



New waist adjustment using straps.



002341RNBO..



002341BNGB..



002341BNBV..



002341GNBG..



002341NAFB..



002341NBRF..

## KERB LADY

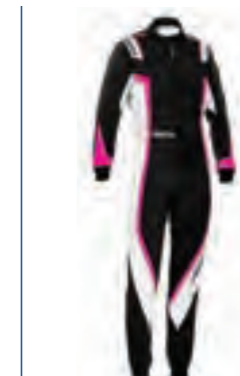

002341LNRBF..



002341LNRGF..



**HOMOLOGATION:** CIK-FIA N2013.1  
**SIZES:** XS-XXL **YOUTH SIZES:** 120-150  
**CUSTOMIZATION:** BY STOCK

**MANUFACTURER:** SPARCO  
**MODEL:** K43 THUNDER  
**HOM. NO:** CIK-FIA 2013/046  
**FIA STANDARD:** N 2013-1

**T. Stolcermanis**  
TEAM ENERGY CORSE  
WSK Euro Series OK Final Winner



## HIGHLIGHTS



Low collar.



Elasticated back panel.



Breathable inserts on inside leg and underarm.



002342RSNR..



002342GSGF..



002342NRAF..



002342NRRS..



002342NRAZ..



002342NRVF..



002342BSGF..



# ROOKIE / ROOKIE YOUTH

HOMOLOGATION: NOT HOMOLOGATED  
SIZES: XS-XXL YOUTH SIZES: 120-150 (NRRS ONLY)

N.Perico  
TEAM ENERGY CORSE  
WSK Mini GR.3 U10 Champion

## HIGHLIGHTS



Under arm elastic insert.



Rear elastic band.



Hidden hip pockets.



002343NRGF..



002343NRRS..

002343NREB..



TEAMWEAR & LIFESTYLE	TEAMWEAR & LIFESTYLE	e-SPORTS	PERFORMANCE	KARTING	KARTING
CAPSULE COLLECTIONS	CLOTHING ACCESSORIES	SIM RACING CHAIRS	SEATS HARNESSES STEERING WHEELS	SHOES / GLOVES PROTECTIONS	SUITS
OUTLET					



# T-1 EVO

WATERPROOF SUIT

SIZES: XS-XXL YOUTH SIZES: 120-150

## HIGHLIGHTS

- 100% thermoplastic polyurethane (TPU).
- Double slider zip.
- Elastic waistband.



Elastic cuff bands.



Light cover flap with velcro.



00239T1E..



# RAIN CLOAK

WATERPROOF

SIZES: S/M - L/XL YOUTH SIZES: 130

## HIGHLIGHTS

- 100% thermoplastic polyurethane (TPU).
- Hood with visor with cord and cord stopper.
- Water resistant.



Front button closure.



Pockets with flap.



002393..



# K-CARBON

## UNDERWEAR

**SIZES:** XXS - XS/S - M/L - XL

**MATERIAL:** 80% POLYPROPYLENE - 12% POLYAMIDE - 4% ELASTANE - 4% CARBON

### HIGHLIGHTS



Flat seams thanks to the use of the extra thin thread.



X-COOL treatment.



\* Ergonomics fibres.

**THE ENDLESS CARBON FABRIC THREAD  
CREATES AN ANTI-STATIC EFFECT.**



002202NREB..



002202BIRS..



002203NREB..



002203BIRS..

\* The combination of these fibres promotes ergonomics, softness and comfort, hygroscopicity, breathability, body heat regulation, heat insulation, waterproofing, anti-static and bacteriostatic properties.



# B-ROOKIE

## UNDERWEAR

**SIZES:** XS-XXL (YOUTH SIZES 8/10Y-10/12Y)

**MATERIAL:** 100% COTTON

### B-ROOKIE T-SHIRT

160 Gsm Short sleeve.

160 Gsm High collar, long sleeve.



002204NR



002205NR



002204BI



002204GF



002204RS



002204AZ



002205BI



002205GF



002205RS



002205AZ

### B-ROOKIE BALACLAVA

**COMPOSITION:** 100% cotton Extra flat seams.



002201BI



002201GF



002201RS



002201AZ



002201NR

### BASIC BALACLAVA

002231N

002231B



### X-COOL RECHARGE

The X-COOL refill extends the refreshing treatment on suit and underwear. The application can be done by machine wash.



001157RECHARGE



# W A D T I N G S H O E S W A L K U N N U



KARTING

SHOES / GLOVES  
PROTECTIONS

PERFORMANCE

SEATS  
HARNESSES  
STEERING WHEELS

e-SPORTS

SIM RACING  
CHAIRS

TEAMWEAR  
& LIFESTYLE

CLOTHING  
ACCESSORIES

TEAMWEAR  
& LIFESTYLE

CAPSULE  
COLLECTIONS

OUTLET



# SHOES INDEX

## K-PRIME NEW

**MATERIAL:** MICROFIBER LEATHER **SOLE:** TPU SOLE WITH DIFFERENTIATED GRIP TEXTURE  
**SIZES:** 37-48 **CUSTOMIZATION:** ON DEMAND



001285..BINR      001285..NRGF

## K-FORMULA

**MATERIAL:** TUMBLED LEATHER + MICROFIBER **SOLE:** OIL AND HYDROCARBON RESISTANT RUBBER  
**SIZES:** 32-34-36 ON DEMAND / 37-48 ON STOCK **CUSTOMIZATION:** ON DEMAND



001298..AZGF      001298..NRGF      001298..NRVF      001298..NRBI

## K-SKID

**MATERIAL:** TUMBLED LEATHER + PU LEATHER **SOLE:** OIL AND HYDROCARBON RESISTANT RUBBER  
**SIZES:** 35-48 **CUSTOMIZATION:** ON DEMAND



001277..NRAF      001277..BMBI      001277..RSNR      001277..NRNR

## K-RUN / K-RUN YOUTH

**MATERIAL:** MESH 3D + MICROFIBER **SOLE:** OIL AND HYDROCARBON RESISTANT RUBBER  
**SIZES:** 35-48 **SIZES YOUTH:** 26-28-30-32-34 **CUSTOMIZATION:** BY STOCK

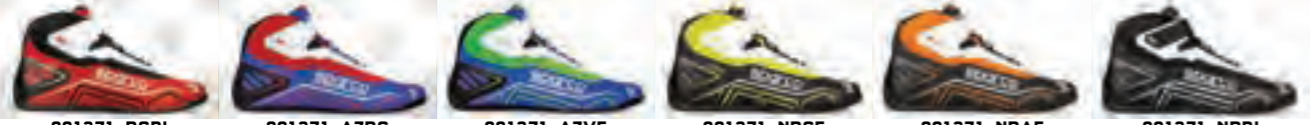

001271..RSBI      001271..AZRS      001271..AZVF      001271..NRGF      001271..NRAF      001271..NRBI

## K-POLE / K-POLE YOUTH

**MATERIAL:** MICROFIBER **SOLE:** OIL AND HYDROCARBON RESISTANT RUBBER  
**SIZES:** 35-48 **SIZES YOUTH:** 28-30-32-34 **CUSTOMIZATION:** ON DEMAND



001269..RSBI      001269..BMBI      001269..NRGF      001269..NRAF      001269..NRAZ      001269..NRNR

## K-POLE WP / K-POLE WP YOUTH

**MATERIAL:** MICROFIBER **SOLE:** OIL AND HYDROCARBON RESISTANT RUBBER  
**SIZES:** 35-48 **SIZES YOUTH:** 26-28-30-32-34



001269WP..NRNR



KARTING

PERFORMANCE  
SEATS  
HARNESSES  
STEERING WHEELS

e-SPORTS  
SIM RACING  
CHAIRS

TEAMWEAR  
& LIFESTYLE  
CLOTHING  
ACCESSORIES

TEAMWEAR  
& LIFESTYLE  
CAPSULE  
COLLECTIONS

OUTLET

SHOES

SEATS  
HARNESSES  
STEERING WHEELS

SIM RACING  
CHAIRS

CLOTHING  
ACCESSORIES

CAPSULE  
COLLECTIONS

OUTLET



NEW

SIZES: 37-48  
CUSTOMIZATION: ON DEMAND



## HIGHLIGHTS

- Inspired by top-level racing boots.
- Upper in smooth microfiber leather.
- Breathable and fresh lining.
- Shock-absorber footbed.
- TPU ultralight sole with differentiated grip texture.
- High abrasion-resistant print on tip and heel parts.



One-piece strap closure system.



Back insert made with elastic fabric for maximum flexibility during the race.

Compliant to the new FIA 8877-2022 requirements.



0012B5..BINR



0012B5..NRGF

KARTING

PERFORMANCE

e-SPORTS

TEAMWEAR & LIFESTYLE

TEAMWEAR & LIFESTYLE

OUTLET

SHOES

SEATS  
HARNESSES  
STEERING WHEELS

SIM RACING  
CHAIRS

CLOTHING  
ACCESSORIES

CAPSULE  
COLLECTIONS



**SIZES:** 32-34-36 ON DEMAND / 37-48 ON STOCK  
**CUSTOMIZATION:** ON DEMAND



## HIGHLIGHTS

- Lightweight breathable lining.
- Silkscreen prints.
- Comfort insole.
- Oil and hydrocarbon resistant rubber sole.
- Customizable on demand.



Closing system with cables and rotor to speed up shoes opening and closing.



Elastic back insert.



001298..AZGF



001298..NRVF



001298..NRGF



001298..NRBI



**SIZES:** 35-48  
**CUSTOMIZATION:** ON DEMAND



## HIGHLIGHTS

- Light and breathable lining.
- Overlap tongue integrated with side.
- Silkscreen printed tumbled calfskin uppers.
- Perforations for maximum breathability.
- Ultra resistant Kevlar loops.
- Comfortable insole.
- Oil and hydrocarbon resistant rubber sole with differentiated grip texture.



Elasticated rear insert.



High abrasion-resistant leather inserts.



001277..BMBI



001277..NRAF



001277..RSNR



001277..NRNR



# K-RUN / K-RUN YOUTH

SIZES: 35-48 YOUTH SIZES: 26-28-30-32-34  
CUSTOMIZATION: BY STOCK



## HIGHLIGHTS

- External lacing with strap.
- Ultra-breathable 3D mesh uppers.
- Thin round laces.
- Internal lateral reinforcement insert.
- Anatomical insole.
- Oil and hydrocarbon resistant rubber sole with differentiated grip texture.



Silkscreen printed microfiber uppers with matt finish.



Printed anti-abrasion insert on heel.



KARTING

PERFORMANCE

e-SPORTS

TEAMWEAR & LIFESTYLE

TEAMWEAR & LIFESTYLE

OUTLET

SHOES

SEATS  
HARNESSES  
STEERING WHEELS

SIM RACING  
CHAIRS

CLOTHING  
ACCESSORIES

CAPSULE  
COLLECTIONS



# K-POLE / K-POLE YOUTH

**SIZES:** 35-48 **YOUTH SIZES:** 28-30-32-34  
**CUSTOMIZATION:** ON DEMAND



Jaime Neto / Filipa Oliveira - eAptiqo AG

## HIGHLIGHTS

- External lacing.
- Thin flat laces.
- Anatomical insole.
- Internal lateral reinforcement insert.
- Oil and hydrocarbon resistant rubber sole with differentiated grip texture.



Silkscreen printed microfiber uppers with matt finish.



Reinforced heel insert.



KARTING  
SHOES

PERFORMANCE  
SEATS  
HARNESSES  
STEERING WHEELS

e-SPORTS  
SIM RACING  
CHAIRS

TEAMWEAR  
& LIFESTYLE  
CLOTHING  
ACCESSORIES

TEAMWEAR  
& LIFESTYLE  
CAPSULE  
COLLECTIONS

OUTLET





# K-POLE / K-POLE YOUTH

**WATERPROOF**

**SIZES:** 35-48  
**YOUTH SIZES:** 28-30-32-34

## HIGHLIGHTS

- Evolution of the K-Pole shoe in WP version.
- External lacing with adjustment.
- Microfibre uppers with matt finish.
- Closure system with cables and rotor.
- Internal lateral reinforcement insert.
- Anatomical insole.
- Oil and hydrocarbon resistant rubber sole with differentiated grip texture.



001269WP..NRNR

# RAIN BOOTS

**WATERPROOF**

**SIZES:** 35-48  
**YOUTH SIZES:** 24-26-28-30-32

## HIGHLIGHTS

- Oil and hydrocarbon resistant rubber sole with differentiated grip texture.
- Neoprene 100% with external coating 80% Nylon + 20% Spandex.



002445..NRNR

# RALLY OVERSHOES

**WATERPROOF**

**SIZES:** S(38,5-40) - M(40-41,5)  
L(41,5-43) - XL(43,5-45)

## HIGHLIGHTS

- Overshoes made of natural rubber, ideal to protect sole on wet or abrasive surfaces.



002431..





# WADING GLOVES WALK LUNGS

KARTING

GLOVES

PERFORMANCE

SEATS  
HARNESSES  
STEERING WHEELS

e-SPORTS

SIM RACING  
CHAIRS

TEAMWEAR  
& LIFESTYLE

CLOTHING  
ACCESSORIES

TEAMWEAR  
& LIFESTYLE

CAPSULE  
COLLECTIONS

OUTLET



**MADE IN ITALY**

## TIDE-K

**PRECURVED:** YES **SEAMS:** EXTERNAL **SIZES:** 8-13 **CUSTOMIZATION:** ON DEMAND - BY STOCK



00286..NRAF 00286..NRVF 00286..RSNR 00286..NRNR

## ARROW-K

**PRECURVED:** YES **SEAMS:** EXTERNAL **SIZES:** 7-12 **CUSTOMIZATION:** BY STOCK



002557..BINR 002557..RSBI 002557..BMBI 002557..NRGF 002557..NRBI

## ARROW-K INFINITY

**CUSTOMIZATION:** ON DEMAND



002558..NRRS

## RECORD

**PRECURVED:** YES **SEAMS:** EXTERNAL **SIZES:** 7-13 **CUSTOMIZATION:** BY STOCK



002555..AZRS 002555..NRRS 002555..NRBI

## RECORD WP

**PRECURVED:** YES **SEAMS:** EXTERNAL **SIZES:** 4-13 **CUSTOMIZATION:** BY STOCK



002555WP..NR

## RUSH

**PRECURVED:** NOT **SEAMS:** INTERNAL **SIZES:** 4-13 **CUSTOMIZATION:** BY STOCK



002556..RSNR 002556..BXNR 002556..BXVF 002556..GRGF 002556..VFNR 002556..GRNR

## CRW

**PRECURVED:** NOT **SEAMS:** HEAT-SEALED **SIZES:** XXS-XL



00260NR..







SIZES: 8-13 CUSTOMIZATION: ON DEMAND - BY STOCK



## HIGHLIGHTS

- Thumb joined to back.
- Internal wrist stitching.
- Precurved glove.
- Touch-S on index finger and thumb.
- Polyethylene and cotton jersey fabric.

### HTX

TECHNOLOGY  
PATENTED  
ALL RIGHTS RESERVED



HTX 3D Volcano palm with differentiated zones.



Ergonomic seam on thumb.



00286..NRAF    00286..NRVF    00286..RSNR    00286..NRNR



# ARROW-K / INFINITY



SIZES: 7-12 CUSTOMIZATION: ON DEMAND



## HIGHLIGHTS

- External seams.
- Thumb finger with outer stitching.
- Polyethylene and cotton jersey fabric.
- Precurved glove.



Ultra grip silicone palm.



Touch-S on index finger and thumb.



002557..BINR



002557..RSBI



002557..BMBI



002557..NRGF



002557..NRBI

**ARROW-K INFINITY**

**002558..NRRS**



# RECORD / RECORD WP

SIZES: 7-13 CUSTOMIZATION: BY STOCK



## HIGHLIGHTS

- External seams.
- Polyethylene and polyamide jersey fabric.
- Sublimation printed back.
- Reinforced in the carpal area.
- Precurved glove.



Palm with differentiated silicone printed grip.



Adjustment strap.



002555..AZRS



002555..NRRS



002555..NRBI

**RECORD WP**

P. 292

002555WP..NR



SIZES: 4-13 CUSTOMIZATION: BY STOCK



## HIGHLIGHTS

- Sublimation printed back.
- Polyethylene and polyamide jersey fabric.
- Wrist with grip print.
- Ultra breathable fabric in the forks.



Synthetic suede leather palm and silicone print.



Internal seams.



002556..RSNR



002556..BXNR



002556..BXVF



002556..VFNR



002556..GRNR



002556..GRGF



# WP ACCESSORIES

## RECORD WATER PROOF GLOVE

SIZES: 4-13 CUSTOMIZATION: BY STOCK

### HIGHLIGHTS

- External seams.
- Antifreeze fleece lining with rainproof membrane.
- Pre-curved glove.
- Adjustment strap.
- Wrist with grip print.
- Palm with differentiated silicone printed grip.
- Reinforced in the carpal area.



002555WPNR..

# CRW

SIZES: XXS-XL

### HIGHLIGHTS

- Neoprene with 80% Nylon, 20% Spandex outer coating. Heat-sealed seams.
- Ergonomic preformed palm with silicone print.



00260NR..

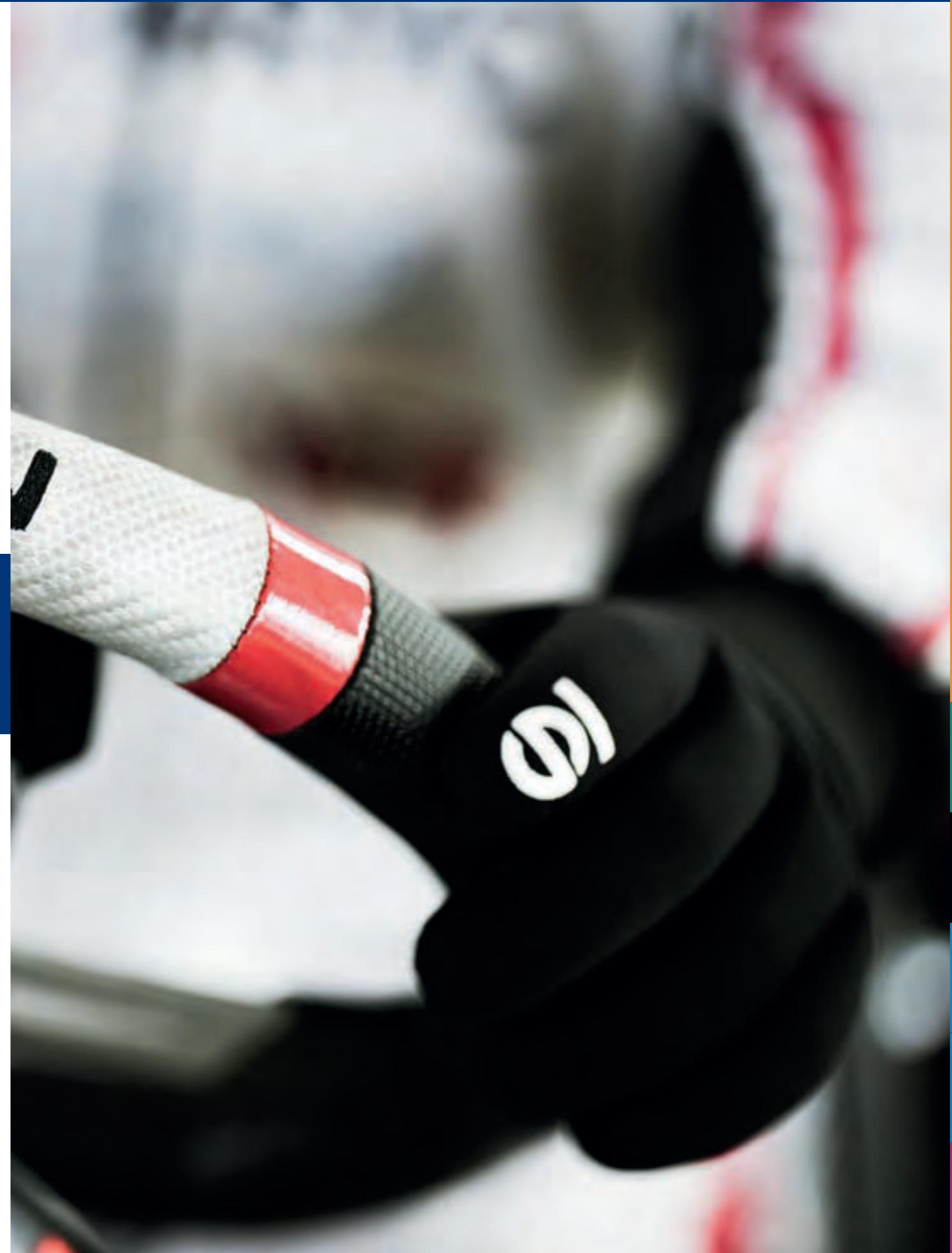

KARTING

GLOVES

PERFORMANCE

SEATS  
HARNESSES  
STEERING WHEELS

e-SPORTS

SIM RACING  
CHAIRS

TEAMWEAR & LIFESTYLE

CLOTHING  
ACCESSORIES

TEAMWEAR & LIFESTYLE

CAPSULE  
COLLECTIONS

OUTLET



sparco  
PRO CARBON

M A D T I N G  
**PROTECTIONS**  
W A K I N G

OUTLET

TEAMWEAR & LIFESTYLE  
CAPSULE COLLECTIONS

TEAMWEAR & LIFESTYLE  
CLOTHING ACCESSORIES

e-SPORTS  
SIM RACING CHAIRS

PERFORMANCE  
SEATS  
HARNESSES  
STEERING WHEELS

KARTING  
PROTECTIONS



**SIZES:** XS-S-M-L-L(WIDE)  
**SHELL MATERIAL:** CARBON+KEVLAR COMPOSITE FIBRE



## HIGHLIGHTS

- Internal foam covered in hypoallergenic fabric and with ventilation channels.
- Automatic elastic adjustment of the side straps and shoulder straps during use.



Ultra-flat front closure system.



Shells made with innovative flexible carbonkevlar for maximum comfort, lightness and fit on the driver.



Flexible back insert to adapt while driving.

## FLEXIBLE LIGHTNESS



002407KNR..

	SIZE	USER CHEST CIRCUMFERENCE (cm)	USER HEIGHT (cm)
KIDS	XS	61,9 - 75	116 to 134
	S	68,5 - 83	134 to 152
MEN	M	80 - 97	152 to 170
	L	89 - 108	152 to 170
	L WIDE	100 - 120	170 to 188



Possibility of customizing shoulder's pullers and sternum pad stickers with kits supplied in the package in **fluorescent yellow** and **red**.





# K-TRACK

8870-2018

HOMOLOGATION: FIA 8870-2018 **SIZES:** XXS-L **YOUTH SIZES:** 120-150  
**SHELL MATERIAL:** MULTILAYERED STRUCTURE



MANUFACTURER: SPARCO  
MODEL: K-TRACK  
HOM. NO: KBP.006.21-A  
FIA STANDARD: 8870-2018

# RIB PRO K-4

**SIZES:** XS-XXL **YOUTH SIZES:** 140  
**SHELL MATERIAL:** THERMOPLASTIC

## HIGHLIGHTS



Customizable with direct printing.



Light and easily adjustable.



Stretch kart fabric lining.



**FLEXIBLE AND ERGONOMIC ADAPTS TO THE SHAPE OF THE BODY IN THE DRIVER'S SEAT.**



002406KNRRS..



002406KNRBI..

## HIGHLIGHTS



High-strength tape.



Adjustable width.



Ultra-strong strap.



002405K..



### SPARCO IMPACT TECHNOLOGY

Sparco Impact Technology: the new technology made in SPARCO® developed by combining a 4 mm EPDM material with a 6 mm PU foam that provides an incredible performance in terms of anti-vibration and shock absorber.





# SJ PRO K-3

SIZES: XS-XXL YOUTH SIZES: 120-140  
EXTERNAL MATERIAL: STRETCH POLYESTER

## HIGHLIGHTS



Preformed and ergonomic back padding.



Elastic band.



Front zip closure.



002402K..

- High shock absorption and anti-vibration performance.
- Great breathability.
- Antibacterial to ensure maximum comfort even during the most intense driving sessions.



### ELBOW PADS

- Stretch, anti-abrasion and breathable outer material.
- En1621-1: 2012 / Level 2 certified PU padding.

SIZE: S-M-L



001551E

### KNEE PADS

- Stretch, anti-abrasion and breathable outer material.
- En1621-1: 2012 / Level 2 certified PU padding.

SIZE: S-M-L



001541K

### K-RING COLLARS

- High density foam collar.
- Sternum support.
- Back support for load distribution on the shoulder blades.
- Fast and safe closing with internal magnet and external strap.
- Removable and washable.



001604NRRS  
001604NRRS-B



001604NRBI  
001604NRBI-B





# AIR KF-7W

**CARBON**

**HOMOLOGATION:** SNELL K 2015

**SIZES:** SMALL SHELL FROM XS TO M+ - LARGE SHELL FROM L TO XL

## HIGHLIGHTS

- Carbon fiber shell reinforced with carbon-kevlar.
- Double size shell and polystyrene with ventilation ducts.
- Removable, adjustable and washable interiors.
- Predisposed for drink system.
- FIA homologated visor with continuous adjustment.



**003354**

CARBON		
<b>XS</b>	53-54	0033540XS
<b>S</b>	55-56	0033541S
<b>M</b>	57-58	0033542M
<b>M+</b>	59	0033543ML
<b>L</b>	60	0033544L
<b>XL</b>	61	0033545XL

# SKY KF-5W

**HOMOLOGATION:** SNELL K 2015

**SIZES:** SMALL SHELL FROM XS TO M+ - LARGE SHELL FROM L TO XXL

## HIGHLIGHTS

- Fiberglass shell reinforced with carbon-kevlar layers.
- Double size shell and polystyrene with ventilation ducts.
- Removable, adjustable and washable interiors.
- Predisposed for drink system.
- FIA homologated visor with continuous adjustment.



**003355**

**003355NR**

WHITE		
<b>XS</b>	53-54	0033550XS
<b>S</b>	55-56	0033551S
<b>M</b>	57-58	0033552M
<b>M+</b>	59	0033553ML
<b>L</b>	60	0033554L
<b>XL</b>	61	0033555XL
<b>XXL</b>	62	0033556XXL

MATT BLACK		
<b>XS</b>	53-54	0033550XSNR
<b>S</b>	55-56	0033551SNR
<b>M</b>	57-58	0033552MNR
<b>M+</b>	59	0033553MLNR
<b>L</b>	60	0033554LNR
<b>XL</b>	61	0033555XLNR
<b>XXL</b>	62	0033556XXLNR



# GP KF-4W CMR

**HOMOLOGATION:** SNELL CMR 2016  
**SIZES:** XS-S-M-L

## HIGHLIGHTS

- Fiberglass shell reinforced with carbon-kevlar layers.
- Continuously adjustable visor.
- Shell with ventilation ducts.



003358

WHITE		
XS	53-54	0033580XS
S	55-56	0033581S
M	57-58	0033582M
L	59	0033583L

# ACCESSORIES

## KART COVER

- Outline for the steering wheel, case included.
- Professional, wide to suit any type of kart.



02712R



02712



02712N

## NEW PAD KIT PRO

- New pads designed for greater comfort.
- New anti-vibration material.
- Design adaptable to all seat types.
- Possibility of repositioning the pad thanks to Velcro.
- Black colour.



02720NR

## TIRE BAG

**COMPOSITION:** 100% polyester

- Light.
- Very resistant.



02702NR



sparco

sparco

# DEEDDEEDDMMANRE SEATS FEKRUWYAVUUE

OUTLET

TEAMWEAR & LIFESTYLE  
CAPSULE COLLECTIONS

TEAMWEAR & LIFESTYLE  
CLOTHING ACCESSORIES

e-SPORTS  
SIM RACING CHAIRS

PERFORMANCE  
SEATS  
HARNESSES  
STEERING WHEELS





# SEATS INDEX

**MADE IN ITALY**

**SPX**   
SHELL MATERIAL: CARBON  
LINING: LEATHER / ALCANTARA®



00974ZN

**SPR**   
SHELL MATERIAL: FIBERGLASS  
LINING: SKY / MICROFIBER



00906NRNR

**QRT PERFORMANCE CARBON / QRT PERFORMANCE**  
SHELL MATERIAL: QRT CARBON / QRT  
LINING: LEATHER / ALCANTARA®



008025ZNRNR



008012RPNR

**GT**  
SHELL MATERIAL: TUBULAR FRAME  
LINING: SKY / MICROFIBER



009012NR



009012NRBI

**R333**  
SHELL MATERIAL: TUBULAR FRAME  
LINING: FABRIC



009011NRRS



009011NRGR



009011NR

**R100 / R100 SKY**  
SHELL MATERIAL: TUBULAR FRAME  
LINING: FABRIC / SKY



009014NRRS



009014NRGR



009014NRAZ



009014NRNR



009014NRSKY

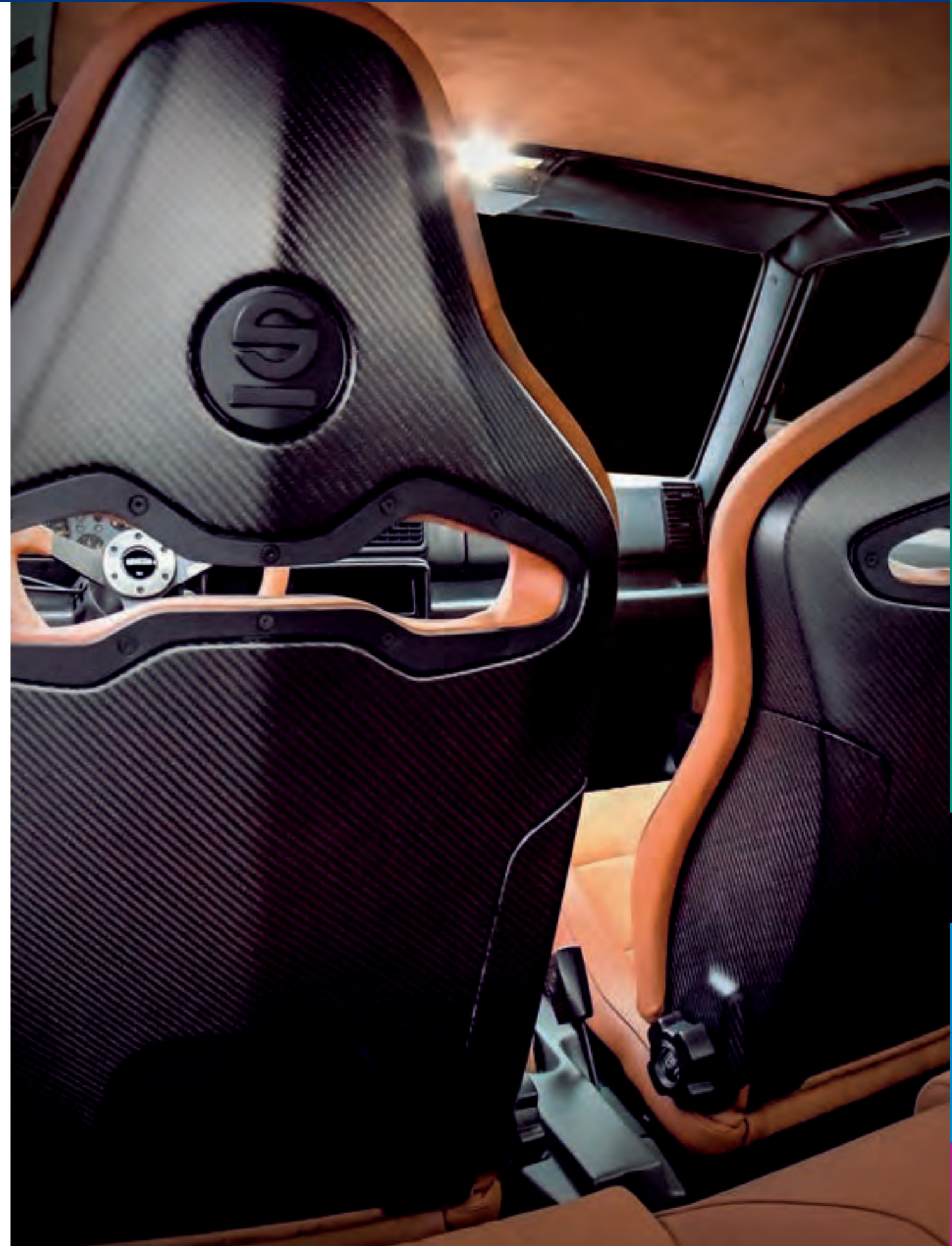



SEAT HANDCRAFTED IN ITALY  
AVAILABLE IN 2 VERSIONS, DRIVER AND PASSENGER

## HIGHLIGHTS

- Hand sewn.
- Backrest with knob for millimetric adjustment.



Reclining carbon fiber seat that meets the same specifications as those imposed on DEMs.



Leather and Alcantara® upholstery.



00974ZNRSX



00974ZNRDX

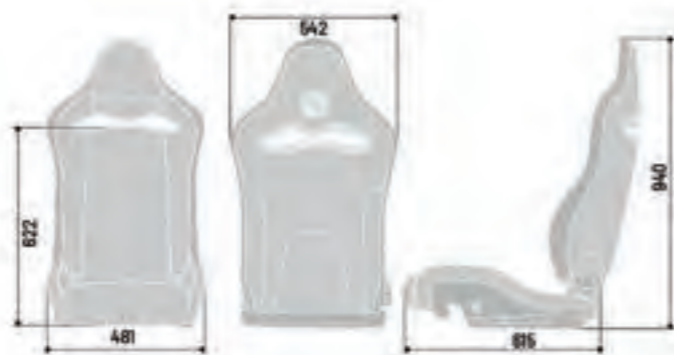

SKY UPHOLSTERY AND MICROFIBER

## HIGHLIGHTS

- 271x345 mm Lower fastening.
- Base set for belt branch mount (7/16" thread).



OEM derived recliner.



Fibreglass frames.



00906NRNR





# QRT PERFORMANCE CARBON

EASY TO INSTALL EVEN IN THE SMALLEST CAR INTERIORS



MANUFACTURER: SPARCO  
MODEL: QRT-C  
HOM. NO: CS.437.19  
FIA STANDARD: 8855-1999

# GT

SKY UPHOLSTERY AND MICROFIBER

## HIGHLIGHTS



Made with Carbon fiber or QRT technology.



Leather and Alcantara® upholstery.



0049616QRT



008025ZNRNR

### QRT PERFORMANCE



MANUFACTURER: SPARCO  
MODEL: QRT-R  
HOM. NO: CS.397.18  
FIA STANDARD: 8855-1999



008012RPNR



## HIGHLIGHTS

- 271x345 mm Lower fastening.
- Steel tubular frame.



Adjustable headrest.



Tilt lever and back adjustment on both sides.



009012NR

009012NRBI







# R333

COMPATIBLE WITH 3 AND 4 POINT SPORTS SEAT BELTS

## HIGHLIGHTS

- 271x345 mm Lower fastening.
- Steel tubular frame.



Modern design and ergonomic sitting.



Double adjustment lever and rapid tilting.



● 009011NRRS ● 009011NRGR ● 009011NR



# R100 / R100 SKY

COMPATIBLE WITH 3 AND 4 POINTS SPORTS SEAT BELTS

## HIGHLIGHTS

- Tubular frame.
- Double adjustment lever and rapid tilting.
- 271x345 mm Lower fastening.



Improved ergonomic: greater lumbar comfort and lowered sitting.



SKY upholstery.



● 009014NRRS

### R100 SKY



● 009014NRSKY



● 009014NRNR



● 009014NRGR



● 009014NRAZ

PERFORMANCE

e-SPORTS

TEAMWEAR & LIFESTYLE

TEAMWEAR & LIFESTYLE

OUTLET

SEATS

SIM RACING CHAIRS

CLOTHING ACCESSORIES

CAPSULE COLLECTIONS



# ACCESSORIES

## SEAT SLIDES, SUBFRAMES FOR BOTTOM MOUNTING

### SLIDE RUNNERS KR



**0049306**

Longitudinal distance 271 mm.

### UNIVERSAL FITTING KIT

With 4 brackets with height adjustment, 2 reinforced aluminium corner pieces and the necessary screws and nuts.



**00495**

### SET OF SLIDE RUNNERS



**00493**

To be fitted between slides and subframes to allow easy access to the rear seats also on cars with front seats with fixed backrest.

Longitudinal distance 271 mm.

### TILT FORWARD BRACKET



**00494**

### ADAPTOR



**00497RACE**

For racing seats on seat rails.  
\*For the complete application list see the price list.

### UNIVERSAL SUBFRAME

With mechanism to adjust the height of the seat, for cars with removable slides from the original seat with distance between slides up to 430 mm.



**00491**





# HARNESSES INDEX

## CLUB H-4R

**ANCHORAGE POINT:** 4 POINTS  
**TYPE:** TRACKDAY / OFFROAD  
**FIXING:** BOLT ON / ROLLCAGE



04609RNR

## CLUB H-4M

**ANCHORAGE POINT:** 4 POINTS  
**TYPE:** TRACKDAY / STRADALE  
**FIXING:** SNAP ON



04604BM1RS

04604BM1AZ

04604BM1NR

## CLUB H-3M DUAL

**ANCHORAGE POINT:** 3 POINTS  
**TYPE:** TRACKDAY / STRADALE  
**FIXING:** SNAP ON



04608DF1RS

04608DF1AZ

04608DF1NR

## CLUB H-4

**ANCHORAGE POINT:** 4 POINTS  
**TYPE:** TRACKDAY / STRADALE  
**FIXING:** BOLT ON

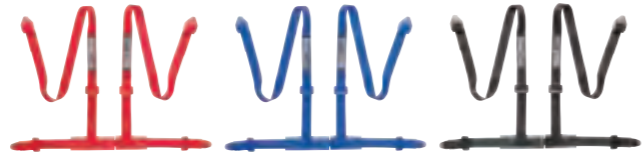

04604BV1RS

04604BV1AZ

04604BV1NR

## CLUB H-3

**ANCHORAGE POINT:** 3 POINTS  
**TYPE:** CLUBMAN  
**FIXING:** BOLT ON



04608BV1RS

04608BV1AZ

04608BV1NR







# CLUB H-4R

NOT FIA APPROVED

## HIGHLIGHTS

- 5-point harness  
NOT FIA APPROVED.
- Screw fixings with hole 15 mm or rollcage by removing the accessories.
- Pad with repositionable tape under the straps for greater comfort.
- Abdominal straps with pulldown tongues adjusters.
- 2 Inch leg.



04609RNR

# CLUB H-4M

HOMOLOGATION: ECE

## HIGHLIGHTS

- 4 fixing points.
- Lap reinforcement.



● 04604BM1AZ

# CLUB H-3M DUAL

HOMOLOGATION: ECE

## HIGHLIGHTS

- 3 fixing points, snap on.
- Double buckle snap on.
- Lap reinforcement.



● 04608DF1NR



# CLUB H-4

HOMOLOGATION: ECE

## HIGHLIGHTS

- 4 fixing points.
- Bolted fixing.

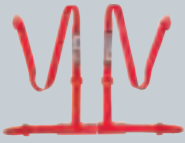

● 04604BV1RS

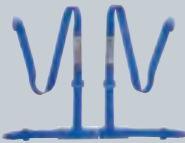

● 04604BV1AZ



● 04604BV1NR

# CLUB H-3

HOMOLOGATION: ECE

## HIGHLIGHTS

- 3 fixing points.
- Bolted fixing.



● 04608BV1AZ



● 04608BV1NR



● 04608BV1RS

# ACCESSORIES

## GT PAD

Thin microfiber pads.



01090R3RS



01090R3AZ



01090R3NR



## MINI

Pair of pads in Microfiber with high grip neoprene inner layer.

- Useful to improve comfort of driving when fitted on steering wheels or handbrake handle.



01099RS



01099AZ



01099NR



## TOW STRAPS

High resistance steel hook.

- Hole diameter: 15 mm.
- Fixed tape.



● 01638NR



● 01638AZ



● 01638ARF



● 001638GF

## MUD FLAPS



- 03791RS
- 03791
- 03791AZ
- 03791NR

Curved polyethylene mud guards kit thickness 1,5 mm.  
Not FIA compliant.

## EXTINGUISHER

### HAND HELD

Ultra-light extinguisher.  
2.0 litre AFFF extinguishing agent.  
Stainless steel cylinder complete with frame and clamp.



014775BXL2



# PERFORMANCE STEERING WHEELS PERFORMANCE



PERFORMANCE  
STEERING WHEELS

e-SPORTS  
SIM RACING  
CHAIRS

TEAMWEAR  
& LIFESTYLE  
CLOTHING  
ACCESSORIES

TEAMWEAR  
& LIFESTYLE  
COLLECTIONS

OUTLET





# STEERING WHEELS INDEX

**TARGA 350**   
DIAMETER (MM): 350



015TARGA350PLNR

**L777**   
DIAMETER (MM): 350



015L800PL



015L800SC

**R383 CHAMPION**   
DIAMETER (MM): 330



015R83PLUNRS



015R83PLUNNR

**R330 CHAMPION**   
DIAMETER (MM): 330



015R330CHAMPION

**L505**   
DIAMETER (MM): 350



015TL522TUV

**L360**   
DIAMETER (MM): 330



015TRGL1TUV



015TRGS1TUV

**L575**   
DIAMETER (MM): 350



015L750PL



015L750SC





# TARGA 350

MATERIAL: LEATHER

## HIGHLIGHTS

Leather.



New horn button colour kit included.

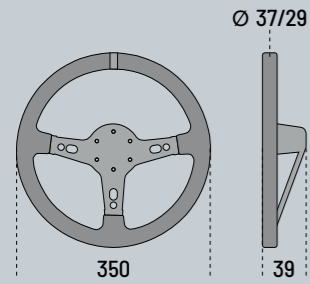

015TARGA350PLNR

# R383 CHAMPION

MATERIAL: PERFORATED LEATHER

## HIGHLIGHTS

Perforated leather.

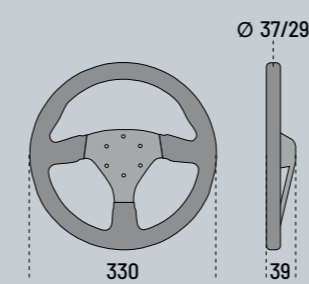

015R383PLUNNR

015R383PLUNRS

# L777

MATERIAL: LEATHER / SUEDE

## HIGHLIGHTS



New horn button colour kit included.

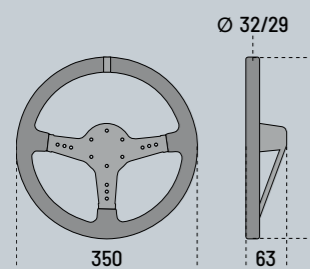

LEATHER



015L800PL

SUEDE



015L800SC

# R330 CHAMPION

MATERIAL: PERFORATED LEATHER

## HIGHLIGHTS

Perforated leather.

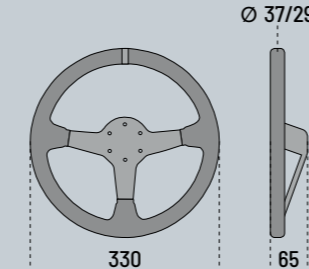

015R330CHAMPION





# L505

MATERIAL: SMOOTH / PERFORATED / SUEDE LEATHER

## HIGHLIGHTS

- Smooth/perforated/suede leather.



New horn button colour kit included.

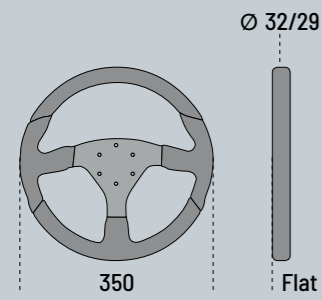

015TL522TUV

# L575

MATERIAL: LEATHER / SUEDE

## HIGHLIGHTS



New horn button colour kit included.

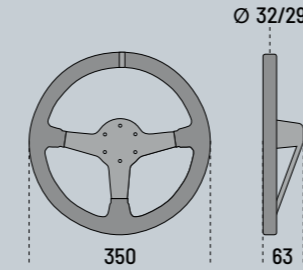

LEATHER

SUEDE



015L750PL



015L750SC

# L360

MATERIAL: LEATHER / SUEDE

## HIGHLIGHTS



New horn button colour kit included.

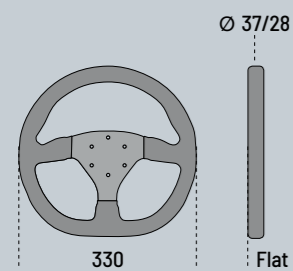

LEATHER

SUEDE



015TRGL1TUV



015TRGS1TUV



PERFORMANCE

STEERING WHEELS

e-SPORTS

SIM RACING CHAIRS

TEAMWEAR & LIFESTYLE

CLOTHING ACCESSORIES

TEAMWEAR & LIFESTYLE

CAPSULE COLLECTIONS

OUTLET





# ACCESSORIES

MADE IN ITALY

# PEDAL SET GEAR KNOBS

## HUB

**FOR THE APPLICATION LIST PLEASE CHECK PRICE LIST.**  
Sparco collapsible hubs are cast iron made with a steel frame that collapse during impacts. This item absorbs kinetics energy avoiding transfer to the driver. The Sparco steering wheels are TÜV approved only if coupled with the Sparco hubs.



## HORN DELETE KIT

**0159ZMNR**  
MATT CARBON

**0159ZNR**  
POLISHED CARBON



## QUICK RELEASE

**015R98TU**



In aluminum with CNC milled steel toothed core. Quick release hub for 6-hole steering wheels with mounting on specific vehicle hub.

## RACING PUSH BUTTONS KIT

**015NE981**

**015NE982**



Black anodized supports with push buttons.

## ANODIZED STEERING WHEEL SPACERS

**01595ANR**  
**01595ANT**

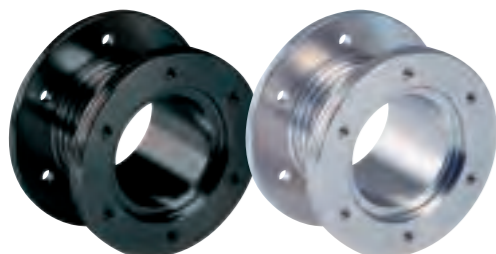

Anodized aluminium.

## RING

**01599NR**



## PIUMA



**03741BN01**



**03741BT01**

Lightened grey/black gear knob.

## SETTANTA



**03736AT**



**03736AO**

Titan/black two colour gear knob.

## CARBON



**03783L (NO ECE)**

3-piece set in mixed carbon. Pre-bent and shaped. Brake and clutch with non-slip inserts.

## SETTANTA - ECE HOMOLOGATED

**037879IT01**



Lightened universal black or silver pedal.

**0378790P04**



**0378790P01**



Set of pedals, Long accelerator pedal.



# 3, 2, 1, GO! SIM RACING GET YOUR FEELERS





**EVOLVE GT-R**

**EVOLVE GT-R PRO** NEW  
 FRAME + PRO BRACKETS + CIRCUIT II SEAT



G0328011GNR

**EVOLVE GT-R RIG I** NEW  
 FRAME + PRO BRACKETS + CIRCUIT II SEAT + FANATEC SIM KIT + R330 LEATHER STEERING WHEEL



G035018011GNR

**EVOLVE GT-R RIG II** NEW  
 FRAME + PRO BRACKETS + CIRCUIT II SEAT + FANATEC SIM KIT + R330 LEATHER STEERING WHEEL + MONITOR STAND + MONITOR + PC + KEYBOARD



G0328012GNR

**EVOLVE GP**

**EVOLVE GP PRO**  
 FRAME + MONITOR STAND + PRO BRACKETS + GP SEAT



G03800NR..

**EVOLVE GP RIG I** NEW  
 FRAME + MONITOR STAND + PRO BRACKETS + GP SEAT + FANATEC SIM KIT + P310 OPEN STEERING WHEEL



G03805..

**EVOLVE GP RIG II** NEW  
 FRAME + MONITOR STAND + PRO BRACKETS + GP SEAT + FANATEC SIM KIT + P310 OPEN STEERING WHEEL + MONITOR + PC + KEYBOARD



G03304..

**EVOLVE KART**

**EVOLVE KART PRO**  
 FRAME + KART PRO BRACKETS + KART SEAT



G03900

**EVOLVE KART ENDURANCE**  
 FRAME + KART ENDURANCE BRACKETS + KART ENDURANCE SEAT



G03920

**EVOLVE KART RIG I** NEW  
 FRAME + KART PRO BRACKETS + KART SEAT + FANATEC SIM KIT + KG345 STEERING WHEEL



G03905

**EVOLVE KART RIG II** NEW  
 FRAME + KART PRO BRACKETS + KART SEAT + FANATEC SIM KIT + KG345 STEERING WHEEL + MONITOR STAND + MONITOR + PC + KEYBOARD



G03904





# EVOLVE GT-R NEW

GT / RALLY DRIVING POSITION

## HIGHLIGHTS

Bundle EVOLVE GT-R RIG II bundle consisting of:

- Evolve GT-R PRO.
- FANATEC SIM KIT (CSL DD 8NM, CSL pedals + Load Cell, Quick Release, Universal Hub v2).
- R330 leather Racing steering wheel.
- PC AK RIG Sparco Edition.
- LOGITECH K400+ wireless keyboard.
- TM-STAND PRO monitor support.
- Samsung ODYSSEY G9 curved monitor - 49" QLED.

### EVOLVE GT-R RIG II



G034018011GNR

## HIGHLIGHTS

Bundle EVOLVE GT-R RIG I bundle consisting of:

- Evolve GT-R PRO.
- FANATEC SIM KIT (CSL DD 8NM, CSL pedals + Load Cell, Quick Release, Universal Hub v2).
- R330 leather Racing steering wheel.

### EVOLVE GT-R RIG I



G035018011GNR



## HIGHLIGHTS

- Evolve GT-R frame.
- GT-R PRO brackets kit.
- CIRCUIT II gaming seat.

### EVOLVE GT-R PRO



G0328011GNR

### EVOLVE GT-R FRAME



081988NRRS

### PRO GT-R BRACKETS



G02400NRRS

### EVOLVE - RHS

Gear shift and RIGHT handbrake support for EVOLVE GT-R.

Allows all handbrake and sequential gear shifts on market.



Right.  
G02085NRRS

### EVOLVE - LHS

Gear shift and LEFT handbrake support for EVOLVE GT-R.

Allows all handbrake and sequential gear shifts on market.



Left.  
G02285NRRS



# EVOLVE GP NEW

FORMULA COCKPIT DRIVING POSITION DERIVED FROM F1

## HIGHLIGHTS

Bundle EVOLVE GP RIG II bundle consisting of:

- Evolve GP PRO.
- FANATEC SIM KIT (CSL DD 8NM, CSL pedals + Load Cell, Quick Release, Universal Hub v2).
- P310 Open Racing steering wheel.
- PC AK RIG Sparco Edition.
- LOGITECH K400+ wireless keyboard.
- Samsung ODYSSEY G9 curved monitor - 49" QLED.

### EVOLVE GP RIG II



## HIGHLIGHTS

Bundle EVOLVE GP RIG I bundle consisting of:

- Evolve GP PRO.
- FANATEC SIM KIT (CSL DD 8NM, CSL pedals + Load Cell, Quick Release, Universal Hub v2).
- P310 Open Racing steering wheel.

### EVOLVE GP RIG I





# EVOLVE GP NEW

FORMULA COCKPIT DRIVING POSITION DERIVED FROM F1

## HIGHLIGHTS

- Integrated monitor support (from 24" to 49").
- Adjustable steering wheel and pedal support.
- Seat with fibreglass frame and customisable padding.

### EVOLVE GP PRO



G03800NR



G03800RS



G03800NRSKY

### F1 STYLE DRIVING POSITION SEATES



008026GRS

008026GMR

008026GNRSKY



Aftermarket brackets Kit for GP cockpit seat. (NO EVOLVE GP)

G02500NRRS

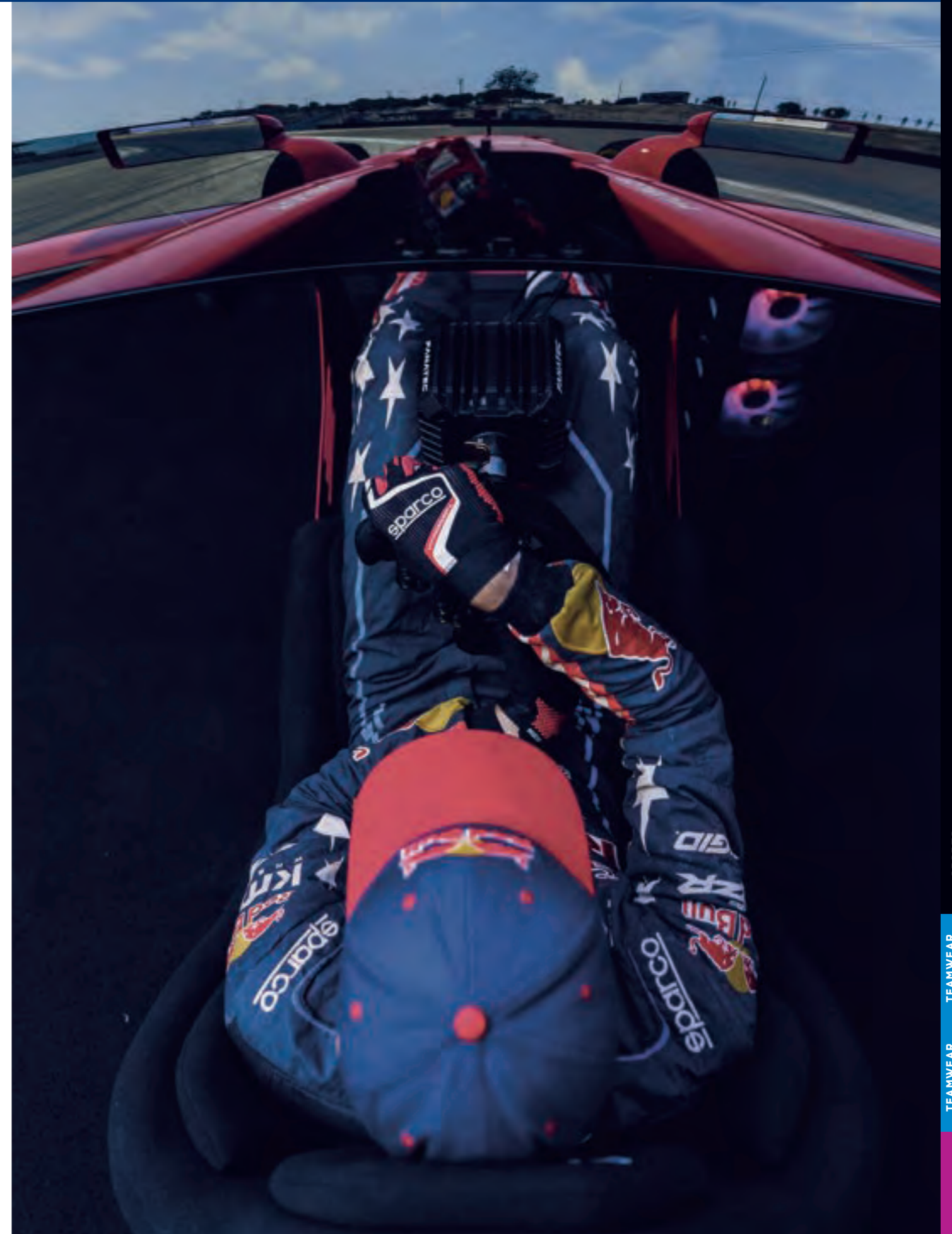



# EVOLVE KART NEW

COCKPIT WITH DRIVING POSITION DERIVED FROM THE REAL KART CHAMPIONSHIP FRAMES.

## HIGHLIGHTS

Bundle EVOLVE KART RIG II bundle consisting of:

- Evolve KART PRO.
- FANATEC SIM KIT (CSL DD 8NM, CSL pedals + Load Cell, Quick Release, Universal Hub v2).
- KG345 Karting steering wheel.
- PC AK RIG Sparco Edition.
- LOGITECH K400+ wireless keyboard.
- TM-STAND PRO monitor support.
- Samsung ODYSSEY G9 curved monitor - 49" QLED.

### EVOLVE KART RIG II



## HIGHLIGHTS

Bundle EVOLVE KART RIG II bundle consisting of:

- Evolve KART PRO.
- FANATEC SIM KIT (CSL DD 8NM, CSL pedals + Load Cell, Quick Release, Universal Hub v2).
- KG345 Karting steering wheel.

### EVOLVE GT-R RIG I



G03904



G03905



# EVOLVE KART NEW

COCKPIT WITH DRIVING POSITION DERIVED FROM THE REAL KART CHAMPIONSHIP FRAMES.

# EVOLVE KART PRO ACCESSORIES

## HIGHLIGHTS

- Evolve Kart frame.
- Kart PRO brackets kit.
- Kart PRO adult seat.

### EVOLVE KART PRO



### EVOLVE KART FRAME

Evolve kart frame. Specific for kart driving position, complete with fiberglass fairings with dedicated kart inspiration graphics. Pedal support adjustable longitudinally, vertically and in inclination. Axial and inclination adjustable support.



081989NR

### SIM KART PRO/JUNIOR BRACKETS

For EVOLVE KART frame and KART PRO and PRO JUNIOR seat.



G02402NR

### NEW KIT PAD PRO

- Adaptable to any type of seat.
- New density, softer.
- Colour: black.



02720NR



G03900

### EVOLVE KART PRO SEAT



G0230013



### EVOLVE KART PRO JUNIOR SEAT

**PRO JUNIOR**  
Seat suitable up to 12 years.



G0230011

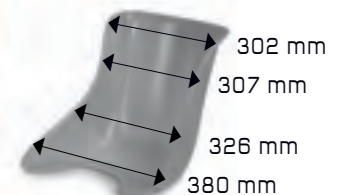

### EVOLVE KART PRO-JUNIOR

Complete kit with small seat, suitable up to 12 years.



G03910

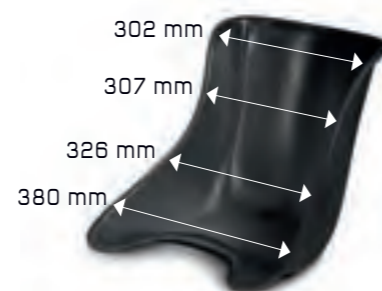



# EVOLVE KART ENDURANCE

COCKPIT WITH DRIVING POSITION DERIVED FROM THE REAL KART CHAMPIONSHIP FRAMES.

## HIGHLIGHTS

- Evolve Kart Endurance frame.
- Kart Endurance brackets kit.
- Kart Endurance adult seat.

### EVOLVE KART ENDURANCE



G03920

# EVOLVE KART ENDURANCE ACCESSORIES

### SIM-KART ENDURANCE SEAT

Sim-Kart seat with comfort seat, suitable for long driving sessions.

Compatible with EVOLVE KART and EVOLVE GT-R.



009103GNRRS

### PRO ENDURANCE SEAT BRACKETS

For EVOLVE KART frame and SIM-KART ENDURANCE seat.



G02401NRRS



# SIM RACING SEATS

NOT FIA APPROVED

## RALLY / GT DRIVING POSITION

### PRO ADV

008017GNR



### CIRCUIT II

008011GNR



### CIRCUIT I

008010GNR



### QRT-R

008012GNR



### PRO2000

008016GNR



### EVO

008007GNR



### EVO L

008013GNR



### EVO XL

008015GNR



### EVO GAMING 77 WRAP

008007WG77NR



### PRO2000 FLUO

008016GFLNRGF



### PRO2000 FLUO

008016GFLNRAF



# SIM RACING ACCESSORIES

## OPTIONAL CUSHIONS

Pair of lumbar side backrests.

- 01022RS
- 01022AZ
- 01022NR



Universal lumbar backrest.



01023

## COCKPIT FLOOR MAT

Sparco gaming cockpit floor mat.

**DIMENSION:** 180 x 120 cm

Graphic printed on resistant TNT (non-woven fabric). Washable.



099101NRRS

## TM-STAND PRO

Height-adjustable tv monitor stand, up to 49".

VESA mount 75x75 and 100x100. New side reinforcement bodies and dimensions implemented for maximum compatibility with all cockpits on the market. Perfect in combination with EVOLVE GT-R and EVOLVE KART.

**DIMENSIONS:** L/D/H 625 mm x 460 mm x (920-1094 mm).

Compatible with EVOLVE KART and EVOLVE GT-R.



G02386NRRS



# ELECTRONIC DEVICES AND STEERING WHEELS

## NEW FANATEC SIM KIT

FANATEC SIM KIT consisting of:

- Servo-base CSL DD 8NM + Boost Kit 180.
- CSL Pedals + Load Cell.
- Quick Release.
- CSL Universal HUB V2.



G02701

## NEW WIRELESS HEADPHONE RACE PRO

PRO wireless gaming headphones.

- Bluetooth chipset: ATS 3015.
- Bluetooth: V5.1.
- Speaker Driver: 40mm.
- Battery capacity: 1000mAh.
- Playing time: 20 hours.
- Standby time: 100 hours.



MG0230043

## NEW HEADLIGHT SPEAKERS PRO

Speakers 2.1 system - USB.

- Frequency: 150Hz-20KHz.
- SNRD>30dB.
- Input sensitivity: 650 mv.
- Power Input: DC 5V.



MG0230044

## R330

- Hole interaxis: 6x70 mm.
- Leather upholstery.



015R330CLO

## P310 OPEN

- Open top, ideal for GT cars.
- Hole interaxis: 6x70 mm.



015P3100PN

## NEW KG 345

- 350 mm diameter.
- Black Alcantara® upholstery, white cross stitching.



0158KG345NR

STEERING WHEELS INDEX [PG. 192](#)



M. Baumel  
Co-driver  
Rally-Raid and DAKAR champion



# HYPERGRIP+ GAMING GLOVES

SIZES: 8-12

## HIGHLIGHTS

- Updated version of the iconic gaming glove.
- Improved fit.
- Improved pad ergonomics.
- Close fit.
- Elastic cuffs.



Added grip zones for better performance.



Touch-sensitive thumb and index finger.



002095..NRRS



002095..NRAZ



002095..NRVF



002095..NRGF

# HYPERGRIP GAMING GLOVES

SIZES: 8-12

## HIGHLIGHTS

- Perforations in the part of the palm that separates the fingers.
- Micro-perforated microfibre on the palm guarantees maximum ventilation without compromising grip.
- Protective foam pads on the palm reduce the stress exerted on the hand.
- Touch-sensitive thumb and index finger.



002094..NRRS

# MECA III GLOVES

SIZES: S-XL

COMPOSITION: 47% POLYESTER 35% SUEDE 18% ELASTANE

## HIGHLIGHTS

- The backs of Meca-3 gloves are made from elasticised, printed, scuff resistant fabric.
- The palms are in synthetic, scuff resistant hide and there are reinforcements positioned between thumb and index finger.
- Pads between the fingers provide better breathing.
- Strap for tighter fitting.



002093NRGF



002093BMAF 002093AZ



002093NR 002093RS



# HYPERDRIVE

GAMING SHOES

SIZES: 38-46



## HIGHLIGHTS

- Shaped ankle to facilitate movement.
- Reflective tape on back.
- Microfibre reinforcements on toe and heel.
- Ergonomic fustbett.
- Racing-inspired sole.



Knitted sock upper with differentiated structures. Ultra breathable.



Fluorescent Logo and Skid.



001293..NRAZ



001293..NRRS

001293..NRGF



001293..NRVF



# HYPER SPEED

## DRIVING SOCKS

**SIZES:** 38/39 - 40/41 - 42/43 - 44/45 - 46/47

**COMPOSITION:** 100% NYLON MICROFIBER SOCK WITH SILVER IONS, HYPOALLERGENIC

### HIGHLIGHTS

- Maximum comfort and breathability.
- Heel tab at back for easy pull-on.

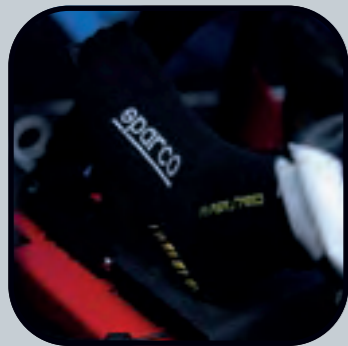

Structure with silicone yarn to maximise the grip.



Asymmetrical Plastisol coating for achieving maximum performance.



Heel reinforced with Cordura®.



01290NR..



Comfort configuration (with removable insole).



Feeling configuration (No insole).



01290NRGF..



01290NRAZ..



01290NRVF..

# B-ROOKIE

## T-SHIRT SHORT SLEEVE

**SIZES:** S-XXL

**COMPOSITION:** 100% COTTON

### HIGHLIGHTS

- Soft cotton 160 GSM.
- Short sleeve.



002204NR



002204BI



002204AZ



002204RS



002204GF

# B-ROOKIE

## T-SHIRT SHORT LONG SLEEVE

**SIZES:** S-XXL

**COMPOSITION:** 100% COTTON

### HIGHLIGHTS

- Soft cotton 160 GSM.
- High collar and long sleeve.



002205NR



002205BI



002205AZ



002205RS



002205GF



# CHAIRES





# TORINO

CHAIR SUPPLIED WITH LUMBAR AND CERVICAL CUSHIONS INCLUDED



## HIGHLIGHTS

- Special VEP and SKY multi-material zone upholstery.
- Cushions and accessories easily installed with strap on VEP.
- Reclining backrest.
- Anti-tip device with backrest lock at 150°.
- Base with SGS/BIFMAX5.1/EN1335 certified piston.
- High resistance polymer spoke with 5 solid wheels.



Seat adjustable in height and inclination.



3D armrests with multidirectional movement.



**00999NRGF 00999NRAF 00999NRAZ 00999NRVF 00999NRNR**

**Warning:** this seat must not be used in a car, it is not a car seat.



# GRIP

SEAT VARIANT WITH FABRIC UPHOLSTERY  
 CUSTOMIZATION: EASY CUSHION APPLICATION ON VEP AREA

## HIGHLIGHTS

- Special VEP and fabric multi-material zone upholstery.
- Reclinable backrest with micrometric lumbar adjustment.
- Cushions and accessories easily installed with strap on VEP.
- Anti-tip device with 150° backrest lock.
- Base with SGS/BIFMAX5.1/EN1335 certified piston.
- High resistance polymer spoke with 5 solid wheels.



Seat adjustable in height and inclination.



2D armrests with multidirectional movement.



00989NRGI 00989NRVF 00989NRAZ

**Warning:** this seat must not be used in a car, it is not a car seat.

# ICON

SPARCO R100S REPLICAS SPORTS CAR SEAT

## HIGHLIGHTS

- Reclinable backrest with micrometric lumbar adjustment.
- Anti-tip device with 150° backrest lock.
- Base with SGS/BIFMAX5.1/EN1335 certified piston.
- High resistance polymer spoke with 5 solid wheels.



Seat adjustable in height and inclination.



2D armrests with multidirectional movement.



00998NRRS 00998NRAZ 00998NRNR

**Warning:** this seat must not be used in a car, it is not a car seat.



# GP LOUNGE

LOUNGE CHAIR WITH VEP OR SKY UPHOLSTERY  
CUSTOMIZATION: ON DEMAND

## HIGHLIGHTS

- Ergonomic chair with F1 style position.
- Fiberglass monocoque seat with VEP or SKY upholstery and removable cushions.
- Lined removable leg rest cushion.



Design tubular frame.

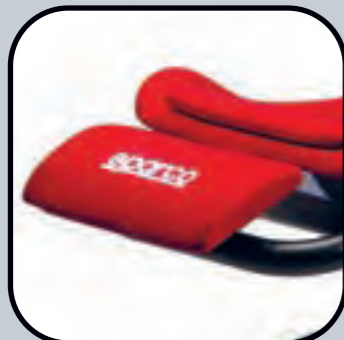

Integrated footrest.



G03700RS



G03700NR



G03700NRSKY

Warning: this seat must not be used in a car, it is not a car seat.

## CHAIR FLOOR MAT

**DIMENSION:** 97,5 x 110 cm.  
Hexagonal shape.  
Graphic printed on TNT.  
Light and resistant.  
Washable.



099102NRRS



## CUSHIONS (STINT AND ICON EXCLUDED)

Ergonomic head cushion.

Universal lumbar backrest.

Lumbar side backrest kit.



01024NR



01023NR



01022RS 01022AZ 01022NR

## ARMRESTS COVER

Compatible with all chairs (Stint excluded).



010810



## PRO CASTER WHEELS

Compatible with all chairs.



010811



# ALPHATOUR TEAMWEAR COLLECTED BY







# WINTER JACKET

**SIZES:** XS-3XL **COMPOSITION:** 100% POLYESTER  
**CUSTOMIZATION:** FULLY CUSTOMIZABLE ON DEMAND



## HIGHLIGHTS

- 2-Layer fabric, waterproof, windproof.
- Double density padding stratification, optimised for extreme climate conditions.
- #9 high strength chain central zip.
- Neck cuff with magnetic closure.
- Elastic cuff inserted in the sleeve bottom.

Hooded winter jacket.

On demand colour



01361GRNR..



01361BMNR..



01361NRAZ..



01361NR..



# SOFT SHELL

**SIZES:** XS-3XL **COMPOSITION:** 100% POLYESTER  
**CUSTOMIZATION:** FULLY CUSTOMIZABLE ON DEMAND

## HIGHLIGHTS

- 3-Layer fabric, waterproof, windproof, with coupled internal fleece.
- Stretch side inserts for comfort and superior fitting.
- Neck cuff with magnetic closure.
- Coated zips.
- Elastic cuff inserted in the sleeve bottom.

Softshell with comfort interior.

On demand colour



01363GRNR..

01363BMNR..

01363NRAZ..

01363NR..

# WINDBREAKER

**SIZES:** XS-3XL **COMPOSITION:** 100% POLYESTER  
**CUSTOMIZATION:** FULLY CUSTOMIZABLE ON DEMAND

## HIGHLIGHTS

- 2-Layer fabric, waterproof, windproof.
- Internal edged seams.
- Hood finished with Sparco customisations.
- Coated zips.
- Drawstring bottom adjustment.

Light hooded windbreaker.

On demand colour



01365GRNR..

01365BMNR..

01365NRAZ..

01365NR..





# VEST

**SIZES:** XS-3XL **COMPOSITION:** 100% POLYESTER  
**CUSTOMIZATION:** FULLY CUSTOMIZABLE ON DEMAND

## HIGHLIGHTS

- Custom coated central zip.
- Reversible, divisible zips.
- Side stretch inserts.
- Internal side pocket.
- Preformed comfort collar.

Windproof, padded, light and lined fabric vest.

On demand colour



01362GRNR..



01362BMNR..



01362NRAZ..



01362NR..

# FULL ZIP SWEATSHIRT

**SIZES:** XS-3XL **COMPOSITION:** 53% COTTON, 41% POLYESTER, 6% ELASTANE  
**CUSTOMIZATION:** FULLY CUSTOMIZABLE ON DEMAND

## HIGHLIGHTS

- Trimmed double faced main fabric.
- Stretch side inserts.
- Stretch inserts on the wrists.

Full zip sweatshirt with coated zips.



01366BMNR..



01366GRNR..



MAN SIZES: XS-3XL LADY SIZES: XS-L COMPOSITION: 96% COTTON, 4% ELASTANE

SIZES: XS-3XL COMPOSITION: 93% POLYAMIDE, 7% ELASTANE  
CUSTOMIZATION: CUSTOMIZABLE UPON REQUEST

## HIGHLIGHTS

- Button down collar.
- Transparent buttons.
- Contrasting collar in Sparco blue.
- Patch woven and sewn on the placket.



Man

013049..

## HIGHLIGHTS

- Made of technical fabric with printed Sparco logos.



Man



Lady



013049L..



013036BI..



013036BM..



013036NR..



013036LBI..



013036LBM..



Lady

013036LNR..





# CORPORATE

## TROUSERS / SHORTS

**SIZES:** XS-3XL **COMPOSITION:** 97% TWILL COTTON - 3% SPANDEX  
**CUSTOMIZATION:** ON DEMAND

# DENIM JEANS NEW

**SIZES:** XS-3XL **COMPOSITION:** 98% cotton, 2% elastane

### HIGHLIGHTS

**Regular fit.**

- Closure with zip and button.
- Sparco label on back pocket.
- Sparco embroidery on right pocket.



Sparco embroidery on pocket.

### TROUSERS



01394NR..

01394BM..

### SHORTS



01395NR

01395BM..

### HIGHLIGHTS

**Slim fit.**

- Denim Jeans stonewashed.
- Sparco fabric labels.
- Original Sparco leather patch.



Sparco embroidery on pocket.



013051BM..





## NEW FRAME VEST

**SIZES:** XS-3XL  
**COMPOSITION:** 100% polyester

- Vest made of technical fabric with printed Sparco logos.
- Outer: 100% matt polyester with TPU membrane (water resistant), 110 g/sqm.
- Knitted softshell side panels.
- Lining: 100% nylon - Padding: 100% down-like polyester, 140 g/sqm.
- External WR zip pocket. Internal pocket on the left side.



013050NR..



013050BM..

## NEW KNITTED COTTON VEST

**SIZES:** S-XXL  
**COMPOSITION:** 100% cotton

- Knitted "V" neck vest with contrasting color details.
- Embroidered logos.



013052NR..



013052BM..

## WILSON WINDSTOPPER

**SIZES:** S-3XL  
**COMPOSITION:** 100% polyester



02405NR..



02405BM..



02405AZ..



02405RS..

## POLO CORPORATE

**SIZES:** S-XXL  
**COMPOSITION:** 100% cotton



01322BI..



01322BM..



01322NR..

## POLO CORPORATE LADY

**SIZES:** S-L  
**COMPOSITION:** 100% cotton



01323BI..



### HOODIE ORIGINAL

**SIZES:** S-XXL  
**COMPOSITION:**  
65% cotton  
35% polyester



01318BI..

**SIZES LADY:** S-L  
**COMPOSITION:**  
65% cotton  
35% polyester



01319BI..

### T-SHIRT ORIGINAL



01327BI..

### HOODIE FRAME

**SIZES:** S-XXL  
**COMPOSITION:**  
65% cotton  
35% polyester



01315NR..



01315BM..



01315RS..

### HOODIE FRAME LADY

**SIZES:** S-L  
**COMPOSITION:**  
65% cotton  
35% polyester



01316NR..



01316RS..

### HOODIE 1977

**SIZES:** S-XXL  
**COMPOSITION:**  
65% cotton  
35% polyester



01320NR..



01320BM..

### T-SHIRT 1977

**SIZES:** S-XXL  
**COMPOSITION:**  
65% cotton  
35% polyester



01329NR..



01329GR..



01329BM..

### T-SHIRT FRAME

**SIZES:** S-XXL **COMPOSITION:** 65% cotton, 35% polyester



01324NR..



01324BI..



01324RS..



01324BM..

### SPORT DRIVE WOOL GLOVE

**SIZES:** S-XL  
**COMPOSITION:** 38% polyester, 26% wool,  
26% acrylic, 5% PU, 5% leather



002082..BM

### T-SHIRT VINTAGE

**SIZES:** S-XXL  
**COMPOSITION:**  
65% cotton  
35% polyester



01326BM..



01326BI..



01326GR..

### T-SHIRT FRAME LADY

**SIZES LADY:** S-L  
**COMPOSITION:**  
65% cotton  
35% polyester



01325NR..



01325RS..

### CREW NECK SWEETSHIRT

**SIZES:** S-XXL  
**COMPOSITION:**  
100% cotton



01321GR..



# S-URBAN

SIZES: 37-48

Tennis sneakers  
80s style.



## HIGHLIGHTS

- White and amber rubber outsole.
- Microfiber upper.
- Lining with pad around the ankle.



0012B4..BIVD



0012B4..BIRS

# S-TIME

SIZES: 36-46

Smart casual sneakers  
with microfiber upper and lining.



## HIGHLIGHTS

- Rubber casual outsole.
- Comfort insole.
- Padding around the ankle.



0012B3..BIAZ



0012B3..BIVD



0012B3..NRBI



# S-DRIVE MID

SIZES: 36-47

Mid cut racing style sneaker.



## HIGHLIGHTS

- Microfiber upper.
- Racing sole.
- Shock absorber and breathable insole in recycled PU with antibacterial treatment.



0012A8..BIBM



0012A8..BMBI



0012A8..NRBI

# S-DRIVE

SIZES: 36-47

Low cut racing style sneaker.



## HIGHLIGHTS

- Microfiber and fabric upper.
- Racing sole.
- Shock absorber and breathable insole in recycled PU with antibacterial treatment.
- Breathable fabric tongue.



0012A7..BINR



0012A7..BMRS



0012A7..NRRS



0012A7..NRGR



SIZES: 36-48

01 CERTIFICATION (EN ISO 20347:2012)  
SIZES: 37-47

Running shoes style.



Ultra-lightweight and breathable  
OCCUPATIONAL footwear.



## HIGHLIGHTS

- Breathable mesh upper with reflective prints.
- Three-dimensional reinforcement print.
- Rubber and phylon sole for maximum grip and comfort.
- Comfortable and anti-bacterial insole.
- Tongue with elastic inserts for maximum foot stability.
- Reflective inserts.



0012A5..BMRS



0012A5..NR

## HIGHLIGHTS

- Tip with ultra-resistant coated reinforcement.
- Breathable mesh lining.
- Energy absorption heel.
- Easy lacing.
- Phylon sole and oil and hydrocarbon resistant rubber bottom.
- SRA level slip resistance.



001289..NRAZ



001289..NRNR



# TOUR TROLLEY BAG

**DIMENSIONS:** H40 X L84 X P38 CM **WEIGHT:** 4,7 KG  
**CAPACITY:** 127 LT **MATERIAL:** COATED POLYESTER

## HIGHLIGHTS

- Double adjustable closure with seat belt style straps.
- Protective padding with racing suit style quilting.
- Lower compartment (2/3). Reinforced on the underside.
- Trolley with reinforced wheels.
- Upper compartment (1/3) with zip opening. Repositionable internal partition. Multi-pocket compartment with net.
- Repositionable internal partitions. Customised Sparco inner lining.



016437NRRS

016437NRSI

# TRAVEL

## SOFT CABIN SIZE TROLLEY

**DIMENSIONS:** H25 X L55 X P35 CM **WEIGHT:** 3 KG  
**CAPACITY:** 48 LT **MATERIAL:** COATED POLYESTER

## HIGHLIGHTS

- Telescopic handle.
- Double adjustable closure with seat belt style straps.
- Protective padding with racing suit style quilting.
- Trolley with reinforced wheels.
- Front document pockets. Customised Sparco inner lining.
- Reinforced on the underside.



016438NRRS

016438NRSI







# DAKAR

## LARGE DUFFLE BAG

**DIMENSIONS:** H70 X L40 X P40 CM **CAPACITY:** 110 L  
**MATERIAL:** WATERPROOF TPU / POLYESTER

### HIGHLIGHTS

- Can be used as a backpack or duffel bag.
- Detachable and adjustable shoulder strap.
- Hidden rain-proof zip.
- Transparent address holder.
- Washable interior.
- Printed logo and also applied on the sides of the product with a rubber label.

**LARGE.**



016442NRAZ



016442NRNR



016442NRRS

# DAKAR

## SMALL DUFFLE BAG

**DIMENSIONS:** H53 X L32.5 X P32.5 CM **CAPACITY:** 60 L  
**MATERIAL:** WATERPROOF TPU / POLYESTER

### HIGHLIGHTS

- Can be used as a backpack or duffel bag.
- Detachable and adjustable shoulder strap.
- Hidden rain-proof zip.
- Transparent address holder.
- Washable interior.
- Printed logo and also applied on the sides of the product with a rubber label.

**SMALL.**



016443NRAZ



016443NRNR



016443NRRS



# SUPERSTAGE

## BACKPACK

**DIMENSIONS:** H52 X L40 X P20 CM **WEIGHT:** 1,10 KG  
**CAPACITY:** 42 LT **MATERIAL:** COATED POLYESTER

### HIGHLIGHTS

- Two sub-funds.
- 15.6" Pc holder and 11" tablet.
- Large front pocket and side pockets.
- Ergonomic backrest.
- Organized interiors.
- Lifting handle covered in soft touch material.
- Padded and adjustable shoulder straps.



016445NRAZ



016445NRNR

# STAGE

## RUCKSACK

**DIMENSIONS:** H40 X L30 X P14 CM **WEIGHT:** 0,76 KG  
**CAPACITY:** 16 LT **MATERIAL:** POLYESTER

### HIGHLIGHTS

- 2 hidden front pockets with graphics that echo the Sparco seat belt slider.
- Ergonomic padded and back lined with breathable mesh, horizontal band for inserting telescopic trolley bag handle.
- Padded seat belt style shoulder straps.
- Inner pocket for inserting PC up to 15". Customised Sparco inner lining.



016440NRRS



016440NRAZ



016440NRNR



# DRYTECH

## HELMET HAND F.H.R COLLAR BAG

**DIMENSIONS:** H35 X L35 X P40 CM **WEIGHT:** 1,3 KG  
**CAPACITY:** 49 LT **MATERIAL:** POLYESTER

### HIGHLIGHTS

- Helmet drying system with USB 12V power cable.
- Fan cover.
- Protective padding with racing suit style quilting. Customised Sparco inner lining.
- Seat belt style shoulder strap.



016441NRSI

# TRIP

## BAG WITH SHOULDER STRAP

**DIMENSIONS:** H35 X L66 X P38 CM **WEIGHT:** 2,1 KG  
**CAPACITY:** 87 LT **MATERIAL:** POLYESTER

### HIGHLIGHTS

- Double handle with seat belt style straps.
- Customised Sparco inner lining.
- Internal pocket with zip closure.
- Protective feet for the underside.



016439NRSI

# BAJA

## MULTINECESSAIRE

**DIMENSIONS:** L22 X 12 X 12 CM  
**CAPACITY:** 3,2 LT **MATERIAL:** POLYESTER

### HIGHLIGHTS

- Material: TPE laminated fabric, polyester.
- D-opening with flap and hinges.
- The internal clip allows you to hang the need for a easier use.
- Internal pockets for small objects.



016446NRNR

# CO-DRIVER

## BAG

**DIMENSIONS:** H35 X L30 X P10 CM  
**CAPACITY:** 10,5 LT **MATERIAL:** POLYESTER

### HIGHLIGHTS

- Supplied with shoulder strap.
- Interior divided into 2 compartments with contrasting lining.
- Several pockets and external pocket in transparent PVC.
- Back with ribbons and eyelets for anchoring with rollbar.

Bag developed with the co-drivers Ingrassia and Andreussi.  
Double closure.



0164281NR



## FLEXFIT - ORIGINAL CAP

**COMPOSITION:** 63% Polyester, 34% cotton, 3% PU baseball cap with elastic band spandex.  
**SIZES:** S-M, L-XL



01357BM..

01357AZ..

01357NR..

01357BI..

## SUEDE

100% Suede cotton six-panel cap with 3d embroidered Logo.



01353BM

01353GR

01353NR

01351BM

01351NR

## STRETCH

100% Polyester technical fabric five-panel cap with raised tpu rubber logo.

## TRUCKER

Trucker cap with visor and 100% cotton suede front panel and 100% pvc rear mesh for ventilation. Embroidered patch on the front.



01352BM

## BEANIE REFLEX

**COMPOSITION:**  
 50% Wool  
 50% Acrylic fabric



01354AZBM

## BEANIE WINDY

**COMPOSITION:**  
 100% Acrylic fabric



01232BMAZ

## NEW ICONIC DESIGN SOCKS

**COMPOSITION:** 80% Combed Cotton, 17% Polyamide, 3% Elastane  
**SIZES:** 36/40 (N1) - 41/46 (N2)



099144X..



099144H..



099144P..



099144SW..

## NEW SUNGLASSES

**CE COMPLIANT**  
 (EN ISO 12312-1 CAT.3 - EU 2016/425) + UKCA



099059FE

- Sunglasses made of coated bamboo and all-over mirrored lens.
- UV400 protection.
- RPET felt case with FULL EFFICIENCY print.

## LOGO BELT

**DIMENSIONS:**  
 120 cm H 4cm  
 Nickel free



01356NR



01356AZ



## GOLF UMBRELLA

Automatic polyester umbrella.  
Ø 130 cm



099068

## LED UMBRELLA

Foldable automatic polyester umbrella with light.  
Ø 96 cm



099105

## PADDOCK

The foldable paddock Chair has an aluminum frame and is finished in coloured Oxford 600D fabric. The soft arms are padded for maximum comfort.



0990058

## POUF

Soft pouf diameter 40 cm, height 40 cm, with printed S Logo in the upper surface.



0750006B

## NEW LIGHT BACKPACK

**DIMENSIONS:**  
29x42x18cm

Foldable travel backpack with internal pocket. Adjustable shoulder straps. 100% Polyester.



0160037GR

## SPORTSACK

**DIMENSIONS:**  
33x51 cm



0160013NR

0160013AZ

## SUIT BAG

**DIMENSIONS:**  
44x35 cm



016BLU07

## TAPPETO INGRESSO

**DIMENSIONS:**  
120x80 cm



099058

## ZERBINO

**DIMENSIONS:**  
80x40 cm



099090

## GYM TOWEL

**DIMENSIONS:** 100x50 cm  
**COMPOSITION:** 90% Polyester, 10% Nylon



099073

## CLOTHES HANGER



099091AZ

## WINDSHIELD BANNER - FRONT

137x17 cm



099097AZ

## WINDSHIELD BANNER - REAR

120x10 cm

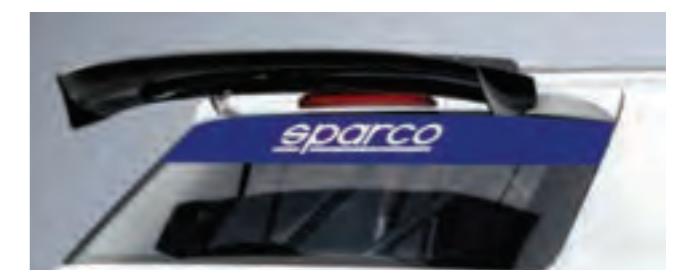

099098AZ



# ACCESSORIES

### WATER BOTTLE

Steel 0,5 L



099106AZ

### MUG

Stainless steel 0,3 L



099112AZ

### LEATHER KEY HOLDER

099070..



NR AZ AF GF RS

### KEY HOLDER

099092TEMWORK 099092GAMING 099092SHOE 099092SPARCO 099092SUIT



### PVC KEY HOLDER

099071GLOVE 099071SEAT



### BRACELETS



099093NR

099093GI

099093BX

099093RS

099093BI

### NOTEBOOK

Sizes A5



099109AZ

### SPIRAL NOTEBOOK

Sizes A5



099110AZ

### LANYARD

Official Gaming



099114AZ

099103NRRS

### METAL PIN

099089



099089

### MAGNET

099111AZ



099111AZ

### KIT OF 10 STICKERS

2 PCS 18 cm  
4 PCS 12 cm  
4 PCS 8 cm

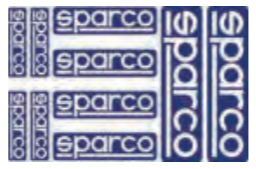

09003





### BABY EAGLE SUIT

Sizes:  
3-6, 6-9  
9-12, 12-18  
18-24 (months)  
100% organic  
cotton with  
digital printing.



017012AZ..

### BABY SLEEPSUIT

Sizes:  
3-6, 6-9  
9-12, 12-18  
18-24 (months)  
100% organic  
cotton with  
digital printing.



017018AZ..

### BABY STRIPE DESIGN

Sizes:  
3-6, 6-9  
9-12, 12-18  
18-24 (months)  
100% organic  
cotton with  
digital printing.



017023BM..

### FUTURE DRIVER

**T-SHIRT**  
Sizes: 3-11 years  
100% cotton with  
digital printing.



017013BI..



017013NR..

### STRIPES DESIGN

**T-SHIRT**  
Sizes: 3-11 years  
100% cotton with  
digital printing.



017020..

### NEXT GENERATION

**HOODIE**  
Sizes: 3-11 years  
100%  
organic cotton  
with silk screen  
printing.



017024BM..

### NEXT GENERATION

**SWEATSHIRT**  
Sizes: 3-11 years  
80% cotton  
20% polyester  
with digital  
printing.



017017NR..

### STRIPES DESIGN

**SWEATSHIRT**  
Sizes: 3-11 years  
80% cotton  
20% polyester  
with digital  
printing.



017021..

### CAP NEXT GENERATION

100% polyester  
3D embroidered Logo.



017028NR

### CAP CORPORATE

100% cotton  
3D Patch.



017027AZ

### CAP REBEL

100% acrylic  
adjustable closure.



017015

### BEANIE REFLEX

50% wool  
50% acrylic  
L:18xH19



017029AZBM

### BEANIE WINDY

100% acrylic  
L:18xH19



017019BMAZ

### BEANIE STRIPES DESIGN

50% wool  
50% acrylic  
L:18xH19



017022BM

### NEW PANDA PLUSH

H.48 cm  
100% Polyester  
compliant with regulation 2009/48/CE.  
Not suitable under 3 years.

LUIGI



099146AZ

MARIA



099146PK







# SK5000I CHILD SEAT **NEW**

(ECE R129/03 - 76-150CM)

HOMOLOGATION: ECE R129/03

- Height-adjustable head rest.
- Strong impact protection.
- Reclining system.
- Wider backrest.
- ISOFIX + TOP TETHER anchorage.



# SK2000I CHILD SEAT **NEW**

(ECE R129/03 - 100-150CM)

HOMOLOGATION: ECE R129/03

- 11 positions of headrest adjustment.
- ISOFIT supported. Two different seating position by pulling adjusting board under seat base.
- Whole body injection moulding.



# F100KI CHILD BOOSTER **NEW**

(ECE R129/03 - 125-150CM)

HOMOLOGATION: ECE R129/03

- 22-36kg.
- Super comfortable with 3cm foaming on seat.
- Strong inner high-resistance structure.







# MAX S2

**MATERIAL:** ALUMINUM ALLOY **RANGE:** MAX 30KM **WEIGHT:** 20KG  
**MAXIMUM SPEED:** 25KM/H **MAX LOAD:** 120KG **BATTERY:** 36V 7.8AH (SMART BMS)  
**CHARGING TIME:** 4 HOURS **MOTOR POWER:** 350 W **WHEELS:** 10"

# ACCESSORIES

## HIGHLIGHTS

- Led display.
- Turn signal.
- Double suspension front  
30km maximum distance  
25km/h maximum speed.



Aluminum alloy.



10 Inch honeycomb tubeless tyres.



Front light + rear light + brake light.



099107AZ

099107NR

**M. McDowell**  
Ford Mustang Dark Horse - NASCAR Cup Series  
**2023 Verizon 200 at the Brickyard Winner**



## E-SCOOTER HELMET

Tg: S-L



099116AZ..

- Bike / electric scooter helmet with a dynamic and sporty design.
- High safety, good ventilation and comfortable fit.



099116GF..

- Material: PC and EPS (polystyrene foam).
- Safety standard: CE / EN1078 (EU), CPSC (USA).



099116NR..

- Sizes:  
S (53-55 cm), 250g  
M (55-58 cm), 260g  
L (58-61 cm), 270g

## PADLOCK



099117AZ

- High strength cable lock for use on electric bikes/scooters.



099117GF

- Material: zinc, brass, abs, pvc, steel.



099117NR

- Dimensions: 12 x 1200 mm.



# FADRIK M-SPORT

## WORLD RALLY CHAMPION







# WINTER JACKET NEW

## M-SPORT TEAMWEAR REPLICA

SIZE: XS-3XL COMPOSITION: 100% POLYESTER

### HIGHLIGHTS

- Winter jacket Replica of teamwear supplied to the M-SPORT team with special THERMORE® padding.
- 2-Layer fabric, waterproof and windproof.
- Double density THERMORE® padding layering, optimized for extreme weather conditions.
- Central zipper with high-strength #9 chain.
- Neck frog with magnetic closure.
- Elasticized cuff inserted into sleeve bottom.



013005MSBM..

# HOODIE NEW

## M-SPORT TEAMWEAR REPLICA

SIZE: XS-3XL COMPOSITION: 65% COTTON, 35% POLYESTER

### HIGHLIGHTS

- MADE in ITALY Hoodie replica of teamwear supplied to the M-SPORT team.
- Available in men's and women's fit.



Man

Lady

013003MSBM..

013004MSBM..

# SOFT SHELL NEW

## M-SPORT TEAMWEAR REPLICA

SIZE: XS-3XL COMPOSITION: 100% POLYESTER

### HIGHLIGHTS

- Teamwear replica softshell jacket supplied to the M-SPORT team.
- 3-layer fabric, waterproof, windproof, with laminated inner fleece.
- Stretch side inserts for comfort and superior fitting.
- Collar strap with magnetic closure.
- Coated zippers.
- Elasticized cuff inserted in sleeve bottom.



013006MSBM..







# HALF-ZIP **NEW**

## M-SPORT TEAMWEAR REPLICA

SIZE: XS-3XL COMPOSITION: 65% COTTON, 35% POLYESTER

### HIGHLIGHTS

- MADE in ITALY 1/4 zipper sweatshirt replica of teamwear supplied to the M-SPORT team.



013001MSBM..

# POLO CORPORATE **NEW**

## M-SPORT TEAMWEAR REPLICA

SIZE: XS-3XL COMPOSITION: FINE COTTON PIQUE (100% COTTON 200GR. SQ. M.)

### HIGHLIGHTS

- MADE in ITALY Polo replica of teamwear supplied to the M-SPORT team.
- Available in men's and women's fit.

Man



013007MSBM..

Lady



013008MSBM..



# T-SHIRT **NEW**

## M-SPORT TEAMWEAR REPLICA

SIZE: XS-3XL COMPOSITION: 95% COTTON 5% ELASTANE

### HIGHLIGHTS

- MADE in ITALY T-shirt replica of teamwear supplied to the M-SPORT team.



013010MSBM..





# HOODIE WRT **NEW**

WORLD RALLY TEAM SPARCO | M-SPORT

SIZE: XS-3XL COMPOSITION: 65% COTTON, 35% POLYESTER

## HIGHLIGHTS

- Made in Italy Hoodie.
- Customized M-SPORT World Rally Team.



013023MSBM..

# T-SHIRT WRT **NEW**

WORLD RALLY TEAM SPARCO | M-SPORT

SIZE: XS-3XL COMPOSITION: 95% COTTON 5% ELASTANE

## HIGHLIGHTS

- Made in Italy T-shirt.
- Customized M-SPORT World Rally Team.



013021MSBM..







# BASEBALL CAP NEW

COMPOSITION: 100% POLYESTER TECHNICAL FABRIC

## HIGHLIGHTS

- Five-panel cap.
- Embroidered logo embossed on visor.
- Sublimated graphics.
- PVC snapback closure.



013025MS

# NECKWARMER NEW

COMPOSITION: 100% POLYESTER

## HIGHLIGHTS

- Multipurpose printed neck warmer.



013026MS





Arturo Merzario  
Targa Florio Champion  
1972 / 1975

PARADISE  
**TARGA FLORIO**  
LULLULESU UUUU

Thanks to Museo Alfa Romeo  
Arese (MI), Italy





# FULL ZIP #F2 NEW

SIZE: XS-3XL COMPOSITION: 65% COTTON, 35% POLYESTER

## HIGHLIGHTS

- Made in Italy.
- Personalized Targa Florio direct embroidery.



# HOODIE #F1 NEW

SIZE: XS-3XL COMPOSITION: 65% COTTON, 35% POLYESTER

## HIGHLIGHTS

- Made in Italy.
- Personalized Targa Florio direct embroidery.







# POLO #P1 NEW

SIZE: XS-3XL COMPOSITION: FINE COTTON PIQUE (100% COTTON 200GR. SQ. M.)

## HIGHLIGHTS

- Polo shirt Made in Italy.
- Personalized Targa Florio.



013040TFBIRS..

013040TFNRRS..

# T-SHIRT #T1 NEW

SIZE: XS-3XL COMPOSITION: 95% COTTON, 5% ELASTANE

## HIGHLIGHTS

- T-shirt Made in Italy.
- Personalized Targa Florio.



013039TFBI..

013039TFBM..







# POLO #P2 **NEW**

**SIZE:** XS-3XL **COMPOSITION:** FINE COTTON PIQUE (100% COTTON 200GR. SQ. M.)

## HIGHLIGHTS

- Polo shirt Made in Italy.
- Personalized Targa Florio.



013048TFBI..



013048TFBM..

# T-SHIRT #T2 **NEW**

**SIZE:** XS-3XL **COMPOSITION:** 95% COTTON, 5% ELASTANE

## HIGHLIGHTS

- T-shirt Made in Italy.
- Personalized Targa Florio.



013047TFBI..



013047TFBM..





# FULL ZIP #AM3 NEW

SIZE: XS-3XL COMPOSITION: 65% COTTON -35% POLYESTER

## HIGHLIGHTS

- Made in Italy.
- Personalized Targa Florio Arturo Merzario.



Arturo Merzario  
CAPSULE

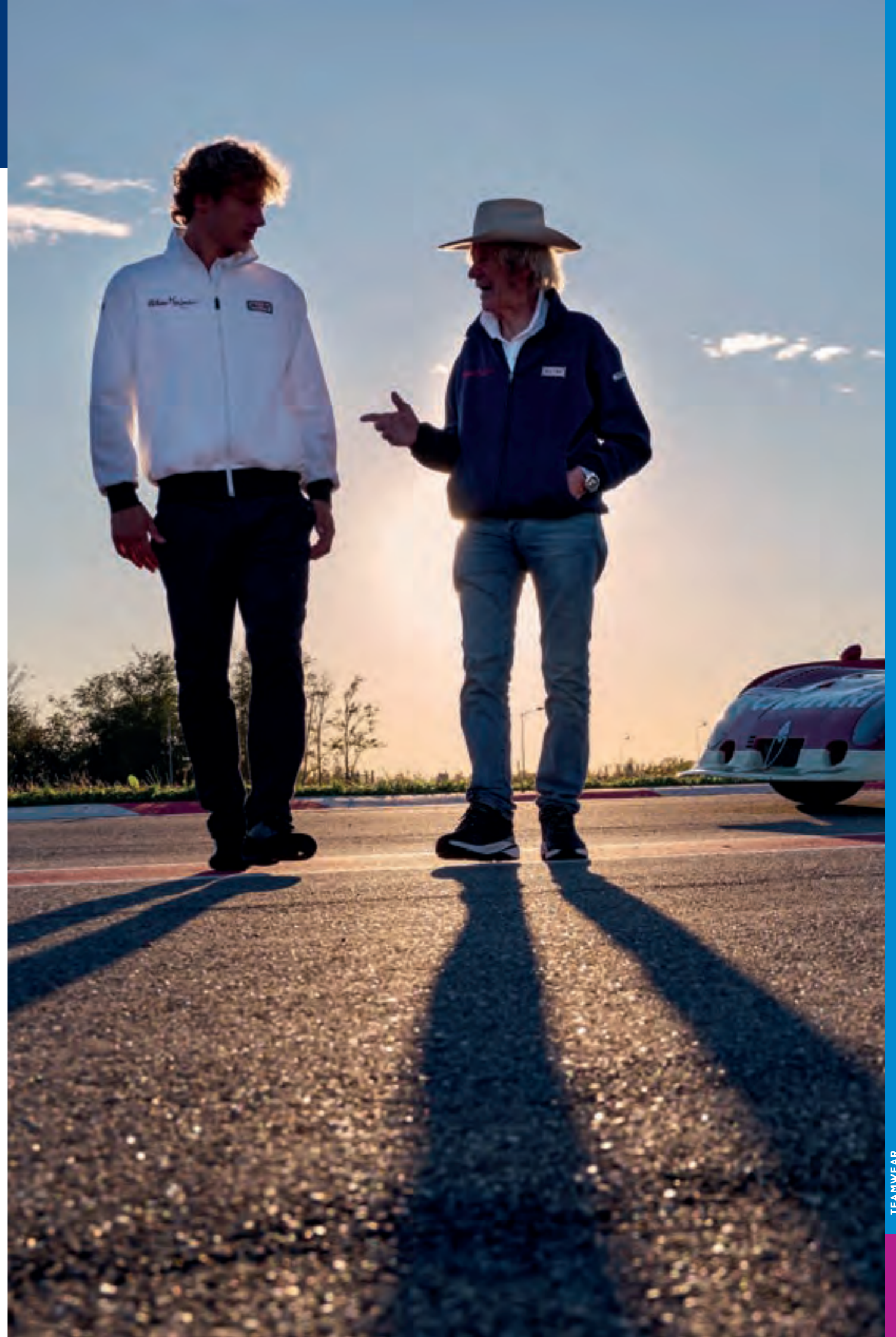





# POLO #AM2 NEW

SIZE: XS-3XL COMPOSITION: FINE COTTON PIQUE (100% COTTON 200GR. SQ. M.)

## HIGHLIGHTS

- Made in Italy.
- Personalized Targa Florio Arturo Merzario.



013045AMBI..

013045AMBM..

*Arturo Merzario*  
CAPSULE

# T-SHIRT #AM1 NEW

SIZE: XS-3XL COMPOSITION: 95% COTTON 5% ELASTANE

## HIGHLIGHTS

- Made in Italy.
- Personalized Targa Florio Arturo Merzario.



013044AMBI..

013044AMBM..

*Arturo Merzario*  
CAPSULE





# BORSA SUPERSTAGE #Z2 NEW

## HIGHLIGHTS

- Holder for 15.6" laptop and 11" tablet.
- Large front pocket and side pockets.
- Ergonomic back.
- Organised interior.
- Lift handle covered with soft-touch material.
- Padded and adjustable shoulder straps.

TARGA FLORIO 42lt customised backpack.



016445TF

# STAGE BACKPACK #Z1 NEW

## HIGHLIGHTS

- Handle covered in soft-touch coated fabric.
- Padded shoulder straps with belt-style straps.
- 2 hidden front pockets with Sparco seatbelt graphics.
- High-visibility front detail.
- 2 side pockets with hidden zip opening.
- Inside pocket with elastic for inserting a PC up to 15".
- Sparco customised inner lining.

TARGA FLORIO customised backpack with padded ergonomic backrest and lined with breathable mesh, horizontal strap for inserting telescopic handle trolley bag.



016440TF







# CAP #C1 NR **NEW**

SIZE: U

## HIGHLIGHTS

- Five-panel cotton cap.
- Embroidered patch logos.
- PVC snapback closure.



013043TF

# LEATHER KEYCHAIN #G1/#G2 **NEW**

## HIGHLIGHTS

- Leather key ring personalised.
- Direct embroidery.



099070TFRS



099070TFNR







# OUTLET



# RACING EQUIPMENT

## RW-11 EVO BALACLAVA

FIA 8856-2018



001408BO 001408NR

## RW-10 SHIELD TECH BALACLAVA

FIA 8856-2018



001402BI 001402NR

## RW-7 DELTA BALACLAVA

FIA 8856-2018



001405BO 001405NR

## RW-10 SHIELD TECH TOP

SIZE:  
XS-S/M-L/XL-XXL  
FIA 8856-2018



001783MBO 001783MNR

## SEAMLESS TOP R570-RW10 PRIME

SIZE:  
XS-S/M-L/XL-XXL  
FIA 8856-2018



001784MBO 001784MNR

## RW-10 SHIELD TECH BOTTOM

SIZE:  
XS-S/M-L/XL-XXL  
FIA 8856-2018



001777PBO 001777PNR

## SEAMLESS BOTT. R570-RW10 PRIME

SIZE:  
XS-S/M-L/XL-XXL  
FIA 8856-2018



001784PBO 001784PNR

## PRIME R

SIZE: 37-48  
FIA 8856-2018



001282BINR 001282NRBI 001282NRRS

## TIDE

SIZE: 8-13  
FIA 8856-2018



001356NRAF

## PRO RJ-3I HERITAGE

SIZE:  
XS-S-M-L-XL-XXL  
FIA 8859-2015



003367AZ..



003367RS..

## PRO 1977 (RJ-I)

SIZE:  
XS-S-M-L-XL-XXL  
FIA 8859-2015



003369AZ..



003369RS..

## AIR PRO 1977 RF-5W

SIZE:  
XS-S-M-L-XL-XXL  
FIA 8859-2015



003375AZ..



003375RS..

## ABS PEAK



00316F01

Black



00316F03



00316F02

Matt black

## NX-1 HEADSET



00537023

## L999



015TMG22TUV

## P222



015THPUGR345 015THPUNR345

## MONZA L550 3 R.CALICE



015TTMZS1



# MECHANICS EQUIPMENT

## SALOPETTE

SIZE: S-XXL



0020011NR..



0020011AZ..

## TIDE MECA (NOT FIA)

SIZE: 8-12



001318..GF



001318..NR

## MECA OVERGLOVES

SIZE: S / M / L



00259NR..



## TORQUE

SIZE: 37-47



001289..BMAF



001289..NRGF



001289..NRRS

## SEATTLE

SIZE: S-XXL



02404BM..



02404NR..



## PHOENIX

SIZE: S-3XL



02406BM..



## PORTLAND

SIZE: S-3XL



02407AZ..



## TRENTON

SIZE: S-XXL



02408AZ..



02407BM..



02408BM..



02407NR..



02408NR..





## PRIME K / PRIME K KID

SIZE:  
44-62 / SIZE KIDS 120-150  
CIK-FIA N2013.1



002308NBGF..

002308NBRS..

## RECORD

SIZE:  
7-13



002555..NRGF

## RUSH

SIZE:  
4-13



002556..AZNR



002556..GRAF

## IL CARBONIO

SIZE:  
XS-XXL



002404K..

## 3IN1 JACKET

SIZE:  
XS-3XL



01364GRNR..



01364BMNR..



01364NRAZ..



01364NR..

## FULL ZIP SWEATSHIRT

SIZE:  
XS-3XL



01366NR..



01366NRAZ..



01368BI..



01369BI..

## SHIRT

SIZE UOMO:  
XS-3XL

SIZE WOMAN:  
XS-XXL

## POLO ZIP

SIZE:  
XS-3XL



01367BI..



01367BMNR..



01367NRAZ..



01367NR..

## HOODIE "VINTAGE"

SIZE:  
S-XXL



01317BI..



01317BM..



## WOOL CREWNECK PULLOVER

SIZE:  
S-XXL



01338BM..



# LEISUREWEAR

## SOFTSHELL TEAMWEAR 20

SIZE:  
XS-XXL



01253AZ..

01253BM..

01257BI..

## SHIRT 20

SIZE:  
XS-XXL



## POLO 20

SIZE:  
XS-XXL



01255BI..

01255AZ..

01255BM..

01255NR..

## VEST PADDED

SIZE:  
S-3XL



02403BM..

## POLO SKID

SIZE:  
XS-XXL



01265NR..

## SPEEDCAT

SIZE:  
36-46



001286..NRBI



## S-LANE

SIZE:  
36-46



001292..NRGR



001292..BMGI



001292..AZBI



001292..NRRS

## S-POLE

SIZE:  
36-48



001288..NGBI



001288..BMBI



001288..NRRG



001288..RBAZ



001288..NRRS



### CREW NECK SWEETSHIRT "NEXT GENERATION"

SIZE:  
3 - 11 Years



017025NR..

### T-SHIRT "NEXT GENERATION"

SIZE:  
3 - 11 Years



017026BI..

017026NR..

### SWEATSHIRT BABY

SIZE:  
3 - 11 Years



017016NR..

### BODY BABY RACER

SIZE:  
3-6, 6-9  
9-12, 12-18  
18-24 Months



017011BI..

### BABY HAT

SIZE:  
0-3, 3-6,  
6-12, 12-24 Months



017014..

### SH-17

SIZE:  
26-34



001262..SIAZ

### KIDS SEAT SK900I

SIZE:  
6 - 12 Years



01921IAZ

01921IGR

01921IRS

### TROOPER



009013NRRS



009013NRAZ



009013NRNR



009013NRVF

### STINT



00988NRRS



00988NRAZ



00988NRNR

### GRIP SKY



00989SKYNRRS



00989SKYNRAZ

### HYPER-T T-SHIRT

SIZE:  
S-XXL



01371NRRS..

### HYPER-P (JOGGER PANT)

SIZE:  
S-XXL



01370NRRS..

### GAMING ROOKIE T-SHIRT

SIZE:  
S-XXL



01360NRRS



# SPARCO GENERAL SALES TERMS AND CONDITIONS

## DEFINITIONS

**Purchaser:** means any party (natural or legal person) that purchases one or more Products, accepting the General Conditions. **General Conditions:** means these general conditions of sale and any future new versions that may be published on the website by SPARCO. **Order Confirmation:** means the e-mail message in which SPARCO notifies the Purchaser about acceptance of the order. **Contracts of Sale:** means the contracts for the sale of Products completed between SPARCO and the Purchaser. **Orders:** means the orders for the purchase of Products submitted by the Purchaser in accordance with the General Conditions. **Parties:** means SPARCO and the Purchaser. **Price:** means the selling price of the Products, as indicated in the On-Line Shop next to each Product. **Products:** means the products presented for sale in the On-Line Shop. **SPARCO:** means Sparco S.p.A. with registered offices at Via Leini 524, Volpiano (Turin), CAP 10088, Italy.

## RECITALS

The following "General Conditions of Sale" govern all sale contracts relating to SPARCO Products, where SPARCO is the seller of the Products. All amendments, clarifications and exceptions to the following general conditions of sale that are agreed and accepted in writing by SPARCO and the Purchaser shall be valid and prevail in the event of conflict. The Purchaser accepts these general conditions, including those regarding use of the trademark, and therefore agrees to comply with all their provisions.

## SUBMISSION OF ORDERS

Orders must be submitted in writing to SPARCO Customer Service by e-mail, or via the SPARCO system designed for the specific purpose of selling the Products. Orders shall be deemed accepted by SPARCO, in the absence of communications to the contrary from SPARCO. Orders for special items are only accepted if accompanied by complete production details.

## RESPONSIBILITIES OF THE PARTIES

The Purchaser is responsible for any erroneous production and/or non-conformities attributable to the supply of incorrect production information when ordering from SPARCO and, consequently, the Purchaser shall still be required to pay the agreed Price. In the case of special and/or customised Orders, SPARCO shall not be responsible for any use of logos, or for any infringement of logos and/or the rules that expressly govern their use and/or any rights claimed by the owner of the logos and/or by any third parties. The Purchaser requesting special production and/or the application of logos to SPARCO Products expressly confirms:

- i. his knowledge of the current regulations governing the use of logos and the civil and/or criminal consequences of any infringements of those regulations;
- ii. his relief of SPARCO from any and all liabilities deriving from and/or connected with the use of logos on SPARCO Products.

## USE OF THE SPARCO TRADEMARK

SPARCO is the owner of the SPARCO trademark (word and figurative mark) and all use of that trademark must be authorised in writing by SPARCO. Use of the SPARCO trademark represents confirmation of the commercial origin of the product SPARCO and its authenticity. Use of the SPARCO trademark and its inclusion in advertising, websites, promotional articles, exhibition stands, window displays, signs, catalogues etc. must always be approved in advance by SPARCO Brand Management and must always comply with the guidelines approved by SPARCO. SPARCO is the only owner of all Internet domain names containing the word "Sparco" and use of the word must be governed by a specific licensing agreement. Use of the SPARCO trademark on third-party products (under licence) is subject to the supervision of SPARCO Brand Management and must be governed by specific contracts signed between SPARCO and the third party concerned. Images of drivers and/or teams that wear/use SPARCO products cannot be used unless specifically authorised by the driver and/or team concerned.

Upon request and by the deadline indicated, the Purchaser has a duty to provide SPARCO with evidence of the use of its name in the Territory, including its use for advertising, selling and/or distribution purposes.

## USE OF THIRD-PARTY LOGOS FOR CUSTOMISATION PURPOSES

In order to use third-party logos on a customised SPARCO Products (company emblems, sponsor logos, photographs etc.) it is necessary to hold rights over them and, therefore, in order to apply a third-party logo, SPARCO requires the Purchaser to confirm in writing that it is:

- i. authorised to use the logo for commercial purposes;
- ii. aware that SPARCO is not responsible for any unlawful use of third-party logos that infringes the rights claimed by their owners and/or by any third parties;
- iii. aware that the unlawful use of protected logos by third parties is punishable by law with application of the envisaged monetary penalties.

## DELIVERY TERMS

The Products are delivered "ex works SPARCO", unless any exceptions are agreed in writing. On shipment, all risks associated with the Products acquired are transferred to the Purchaser.

## PRODUCT RANGE, PRICES AND PAYMENT

The Products illustrated in the SPARCO catalogues and/or price lists are merely indicative, as SPARCO reserves the right to modify the range, the specifications and the prices of Products at any time.

If changes are made following the Order Confirmation, SPARCO will inform the Purchaser on a timely basis.

The ownership of SPARCO Products is only transferred to the Purchaser on completion of the payment.

Failure to pay an invoice will result in an immediate freeze on shipments and the acceptance of new Orders.

## WARRANTY AND RETURN PROCEDURES

SPARCO Products are warranted against manufacturing defects for a period of 2 (two) years from the date of purchase. This warranty is void if Products are altered and/or used and/or maintained improperly, as determined with reference to the User and Maintenance Manual (when supplied). The SPARCO warranty excludes all labour and transport costs. The Purchaser accepts the SPARCO warranty conditions regarding the use and maintenance of the Products. Complaints about damaged shipments and/or theft must be notified to the courier before acceptance of the Products by the Purchaser. Requests for credit for damage and/or theft will be ignored unless specific reservations are written on the delivery documents presented by the courier.

Manufacturing defects must be notified to SPARCO within 30 (thirty) days from the date of delivery.

With regard to material or manufacturing defects, howsoever arising and with whatsoever consequences, SPARCO shall only be required to replace, repair or credit the price for the defective product, at its sole discretion. All complaints and returns under warranty must be authorised in writing by SPARCO before the Products are returned. Such authorisation will be given or refused on the basis of the description of the defect/complaint and the evidence provided by the Purchaser. Authorisation of the return shall not be deemed acceptance of the complaint or a reason for replacement. Products no longer in production or whose type approval has expired cannot be returned, except in the case of recognised manufacturing defects.

All Products returns must be received "carriage paid" by SPARCO and must be accompanied by delivery documents that are complete and accurate in all respects (quantity/item code/description).

## COMPLIANCE WITH THE CODE OF ETHICS

Pursuant to the provisions of Decree 231 dated 8 June 2001 and subsequent amendments and additions (the "Decree"), as well as to the principles, regulations and standards envisaged in the organisation, management and control model adopted by SPARCO pursuant to the Decree (the "Model") and the code of ethics containing the corporate ethical standards adopted by SPARCO (the "Code of Ethics"), SPARCO has published the Model and the Code of Ethics on the SPARCO website, [www.sparco-official.it](http://www.sparco-official.it).

SPARCO invites the Purchaser to read the Model and Code of Ethics, to comply with the principles and values expressed in the Code of Ethics, to behave in a manner consistent with the Model and, in all cases, to behave in a way that does not expose SPARCO to the risk of incurring the penalties envisaged in the above Decree.

## JURISDICTION

All disputes relating to these General Conditions of Sale and to the sales governed by them shall be referred to the sole jurisdiction of the Milan Court.

## PRIVACY

All information processed by SPARCO that is identifiable as "personal data" will be processed in full compliance with current regulations, with particular reference to Regulation (EU) 2016/679 ("GDPR"), Decree 196/2003 and all other applicable regulations.





PIRELLI

WRC  
sparco

20  
WRC  
TOYOTA  
MOTUL  
SARL





sparco®

sparco®

sparco®

sparco®

sparco®

ORACLE

OK  
2023





**THE POWER OF PERFORMANCE**





**sparco**®

**HEADQUARTERS**

**SPARCO S.p.A.**

Via Leini, 524  
10088 Volpiano (TO) - Italy  
Tel. +39 011 22.40.911  
e-mail: [info@sparco.it](mailto:info@sparco.it) - [www.sparco-official.com](http://www.sparco-official.com)

**BRANCHES**

**SPARCO MOTOR SPORTS, INC. U.S.A.**

1852 Kaiser Ave. - Irvine, CA 92614  
Tel. (+1)-949-797-1750  
[www.sparcousa.com](http://www.sparcousa.com)

**SPARCO INDUSTRIE NORD AFRIQUE**

km 32, Ettouta, 8030 Grombalia, Nabeul  
Tel. 00216 72215187

